

Steckanschlüsse und Funktionsverschraubungen

Steckverschraubungen

Seite B3  Zange	Seite B4  Typ: 030 / 031	Seite B6  Typ: 032	Seite B7  Typ: 033	Seite B9  Typ: 033LK	Seite B9  Typ: 033IG	Seite B10  Typ: 033W	Seite B10  Typ: 034IG
Seite B11  Typ: 034 / 035	Seite B13  Typ: 036 / 037	Seite B14  Typ: 037IS	Seite B15  Typ: 037L / T	Seite B15  Typ: 037H	Seite B16  Typ: 038 / 039	Seite B16  Typ: 039	Seite B17  Typ: 040
Seite B18  Typ: 041	Seite B18  Typ: 042 / 043	Seite B19  Typ: 044 / 045	Seite B20  Typ: 046	Seite B20  Typ: 046WS	Seite B20  Typ: 047	Seite B21  Typ: 048	Seite B21  Typ: 048SN
Seite B21  Typ: 049 / 50	Seite B22  Typ: 051	Seite B22  Typ: 052	Seite B23  Typ: 053	Seite B23  Typ: 054	Seite B23  Typ: 055	Seite B24  Typ: 056	Seite B24  Typ: 058
Seite B24  Typ: 059	Seite B25  Typ: 060	Seite B25  Typ: 061SD	Seite B25  Typ: 061	Seite B25  Typ: 061SE	Seite B27  Typ: 030-U/N	Seite B28  Typ: 033-U/N	Seite B28  Typ: 034-U/N
Seite B29  Typ: 047	Seite B29  Typ: 046	Seite B29  Typ: 051	Seite B29  Typ: 052	Seite B30  Typ: 048	Seite B30  Typ: 060	Seite B30  Typ: B088	Seite B31  Typ: MFK
Seite B32  Typ: MFKR412	Seite B32  Typ: 062NI	Seite B32  Typ: 062VB / FB					

MINI-Serie



Funktionsverschraubungen



Schlauchlösezange

Anwendung: Montage und Demontage von Schläuchen aus Steckverbindern
Material: PA6 glasfaserverstärkt
Lange Version: Optimiert speziell für den Einsatz bei engen Einbauten, wie z.B. bei Ventilinseln

Vorteile:

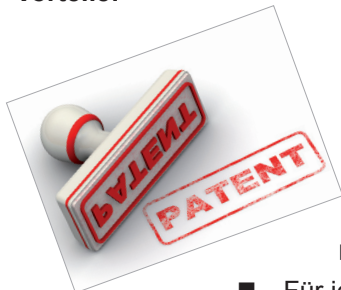

- Einfache und schnelle Demontage / Montage von Schlauch und Steckverschraubung
 - Fest sitzende Schläuche lassen sich leichter lösen
 - Unkomplizierte Handhabung der Zange
 - Kompaktes Zangenformat mit ergonomisch geformtem Softgriff
 - Zange aus hochwertigem Kunststoff (PA6)
- Extrem robust bei gleichzeitig geringem Werkzeuggewicht
- Für jede Größe eine Zange, kein langes Wechseln nötig

Anleitung zur richtigen Anwendung der Schlauchlösezange:



1. Legen Sie die Zange in Ausgangsstellung direkt an den Lösering der Steckverschraubung an. Achten Sie darauf, dass der Schlauch sauber in der Führung liegt und die Zange waagrecht zur Steckverschraubung ist - siehe Bild "Richtig".

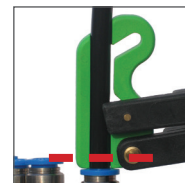

RICHTIG!



2. Drücken Sie die Zange langsam bis zum Anschlag zusammen, so dass der Schlauch aus der Steckverschraubung gelöst wird.

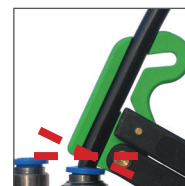

FALSCH



3. Um den Schlauch aus der Zange zu entnehmen, drücken Sie die Zange fest zusammen. Sie können den gelösten Schlauch nun aus der Zange entnehmen.



Schlauchlösezange - Ausführung „Standard“

AUSLAUFTYP

PA 6 glasfaserverstärkt

Bestell-Nr.	Schlauch		Nettopreis Euro
	Ø außen	Aufdruck	
Zangenset-B	4 & 6 & 8	bender pneumatic	49,50
Zange-4-B	4	bender pneumatic	17,45
Zange-6-B	6	bender pneumatic	17,45
Zange-8-B	8	bender pneumatic	17,45



Schlauchlösezange - Ausführung „lange Version“

PA 6 glasfaserverstärkt

Bestell-Nr.	Schlauch		Nettopreis Euro
	Ø außen	Aufdruck	
Zangenset-B-L	4 & 6 & 8	bender pneumatic	99,00
Zange-4-B-L	4	bender pneumatic	34,95
Zange-6-B-L	6	bender pneumatic	34,95
Zange-8-B-L	8	bender pneumatic	34,95

Steckanschlüsse

Steckanschlüsse mit ovalem Lösering

Die Vorteile des ovalen Löserings

- Großer Ø:** Fingerauflagefläche durch den ovalen Lösering wesentlich vergrößert
- Kleiner Ø:** Einbaumaße durch den ovalen Lösering verkleinert
- Innensechskant:** Einbau durch den Innensechskant teilweise noch enger möglich
- Ausführungen:** Sie können wählen zwischen Teflon-Beschichtung für 1/8" bis 1/2" und gekammerter O-Ring-Abdichtung für alle metrischen Gewinde M3, M5 und M7, sowie zölligen G-Gewinde von G1/8" bis G1".
- O-Ring-Abdichtung:** Die O-Ring-Abdichtung ab 1/8" Gewinde dichtet auch nach mehrfachem Montieren zuverlässig. Ein Zerquetschen des O-Ringes durch zu starkes Anziehen ist aufgrund der gekammerten Ausführung nicht möglich.
- Funktion:**
Einstecken: Die rostfreien Einsteckkrallen ermöglichen ein noch leichteres Einstecken.
Dichtlippen: Verbesserte Elastizität, damit wird noch sicherer abgedichtet, auch bei größeren Schlauchtoleranzen.

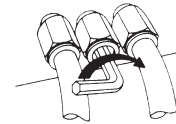
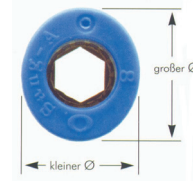

Technische Daten

- Werkstoffe:** Körper: Messing vernickelt/Kunststoff;
Dichtring: NBR
- Temperatur:** -20 °C bis +80 °C
- Betriebsdruck:** -0,95 bis 20 bar
- Medien:** Druckluft, neutrale Gase, (bedingt) Wasser

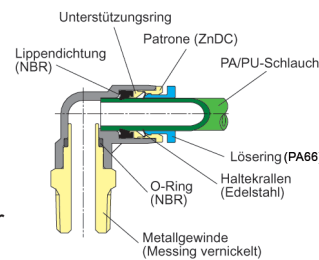

Steckverschraubungen (Typ QS-B) - mit Innen- und Außensechskant

Bestell-Nr.	Schlauch		A	B	H1	H2	DN	Euro
	Ø	Gewinde						
030-18-4	4	R1/8	8,0	20,1	10,0	3,0	3,0	1,10
030-18-6	6	R1/8	8,0	22,0	11,0	4,0	4,0	1,07
030-18-8	8	R1/8	8,0	27,7	13,0	5,0	5,0	1,16
030-18-10	10	R1/8	8,0	29,4	17,0	5,0	5,0	1,67
030-14-4	4	R1/4	11,0	20,1	14,0	3,0	3,0	1,22
030-14-6	6	R1/4	11,0	22,8	14,0	4,0	4,0	1,16
030-14-8	8	R1/4	11,0	25,7	14,0	6,0	6,0	1,19
030-14-10	10	R1/4	11,0	32,4	17,0	6,0	6,0	1,55
030-14-12	12	R1/4	11,0	35,4	19,0	6,0	6,0	2,12
030-38-6	6	R3/8	12,0	21,8	17,0	4,0	4,0	1,49
030-38-8	8	R3/8	12,0	23,7	17,0	6,0	6,0	1,46
030-38-10	10	R3/8	12,0	28,4	17,0	8,0	8,0	1,64
030-38-12	12	R3/8	12,0	31,8	19,0	8,0	8,0	2,12
030-38-14	14	R3/8	12,0	39,0	22,0	8,0	8,0	4,98
030-38-16	16	R3/8	12,0	39,7	24,0	8,0	8,0	5,01
030-12-8	8	R1/2	15,0	26,7	21,0	6,0	6,0	2,18
030-12-10	10	R1/2	15,0	27,3	21,0	8,0	8,0	2,06
030-12-12	12	R1/2	15,0	33,8	21,0	8,0	8,0	2,47
030-12-14	14	R1/2	15,0	36,5	22,0	10,0	10,0	5,07
030-12-16	16	R1/2	15,0	42,2	24,0	10,0	10,0	4,71

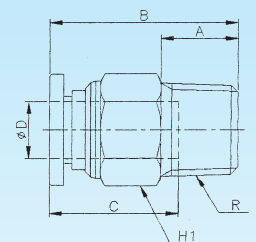

Steckverschraubungen (Typ QS-G-B) - mit Innen- und Außensechskant

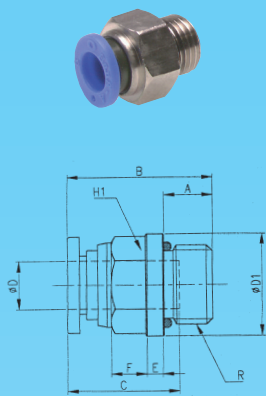

Schlauch									
Bestell-Nr.	Ø	Gewinde	A	B	H1	H2	DN	Euro	
030-5-4*	4	M5	4,0	20,1	8,0	2,0	2,0	1,34	
030-5-6*	6	M5	4,0	21,8	11,0	2,0	2,0	1,46	
030-18-4G	4	G1/8	5,0	18,4	13,0	3,0	3,0	1,10	
030-18-6G	6	G1/8	5,0	23,1	13,0	4,0	4,0	1,07	
030-18-8G	8	G1/8	5,0	26,0	13,0	5,0	5,0	1,16	
030-18-10G	10	G1/8	5,0	27,6	16,0	5,0	5,0	1,67	
030-14-4G	4	G1/4	6,0	18,1	16,0	3,0	3,0	1,22	
030-14-6G	6	G1/4	6,0	19,8	16,0	4,0	4,0	1,16	
030-14-8G	8	G1/4	6,0	21,7	16,0	6,0	6,0	1,19	
030-14-10G	10	G1/4	6,0	28,3	16,0	6,0	6,0	1,55	
030-14-12G	12	G1/4	6,0	32,4	19,0	6,0	6,0	2,12	
030-38-6G	6	G3/8	7,0	18,8	20,0	4,0	4,0	1,49	
030-38-8G	8	G3/8	7,0	22,7	20,0	6,0	6,0	1,46	
030-38-10G	10	G3/8	7,0	24,3	20,0	8,0	8,0	1,64	
030-38-12G	12	G3/8	7,0	32,4	20,0	9,0	8,0	2,12	
030-38-14G	14	G3/8	7,0	34,5	22,0	9,0	8,0	4,98	
030-38-15G*	15	G3/8	Sonder-Ausführung komplett Kunststoff schwarz						10,73
030-38-16G	16	G3/8	7,0	35,5	24,0	9,0	8,0	5,01	
030-12-8G	8	G1/2	8,5	23,7	24,0	6,0	6,0	2,18	
030-12-10G	10	G1/2	8,5	24,8	24,0	8,0	8,0	2,12	
030-12-12G	12	G1/2	8,5	28,9	24,0	10,0	8,0	2,47	
030-12-14G	14	G1/2	8,5	36,0	24,0	11,0	10,0	5,07	
030-12-15G*	15	G1/2	Sonder-Ausführung komplett Kunststoff schwarz						8,11
030-12-16G	16	G1/2	8,5	36,5	24,0	11,0	10,0	4,71	
030-12-18G*	18	G1/2	Sonder-Ausführung komplett Kunststoff schwarz						8,28
030-12-22G*	22	G1/2	Sonder-Ausführung komplett Kunststoff schwarz						15,88
030-34-22G*	22	G3/4	Sonder-Ausführung komplett Kunststoff schwarz						8,58
030-34-28G*	28	G3/4	Sonder-Ausführung komplett Kunststoff schwarz						52,72
030-10-28G*	28	G1	Sonder-Ausführung komplett Kunststoff schwarz						49,41

* ohne Innensechskant

Steckverschraubungen (Typ QSI-B) - mit Innensechskant und rundem Körper für noch engere Einbaumöglichkeiten

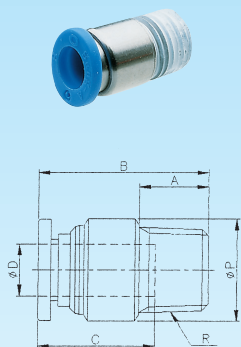

Schlauch								
Bestell-Nr.	Ø	Gewinde	B	A	H	Ø P	DN	Euro
031-5-4	4	M5	20,1	4	2	8	2	1,52
031-5-6	6	M5	21,8	4	2	11	2	1,58
031-18-4	4	R1/8	20,1	8	3	10	3	1,55
031-18-6	6	R1/8	22,0	8	4	11	4	1,67
031-18-8	8	R1/8	27,7	8	5	13	5	1,67
031-18-10	10	R1/8	29,4	8	5	16	5	2,18
031-14-4	4	R1/4	20,1	11	3	14	3	1,88
031-14-6	6	R1/4	22,8	11	4	14	4	1,79
031-14-8	8	R1/4	25,7	11	6	14	6	1,85
031-14-10	10	R1/4	32,4	11	6	16	6	2,38
031-14-12	12	R1/4	35,4	11	6	19	6	2,86
031-38-8	8	R3/8	23,7	12	6	17	6	2,09
031-38-10	10	R3/8	28,4	12	8	17	8	2,50
031-38-12	12	R3/8	31,8	12	8	19	8	2,89
031-12-10	10	R1/2	27,3	15	8	21	8	3,10
031-12-12	12	R1/2	33,8	15	8	21	8	3,22

Steckverschraubungen (Typ QSI-G-B) - mit Innensechskant und rundem Körper für noch engere Einbaumöglichkeiten

Bestell-Nr.	Schlauch		B	A	H	Ø P	DN	Euro
	Ø	Gewinde						
031-18-4G	4	G1/8	18,4	5,0	3	14	3	1,61
031-18-6G	6	G1/8	23,1	5,0	4	14	4	1,70
031-18-8G	8	G1/8	26,0	5,0	5	14	5	1,88
031-14-6G	6	G1/4	19,8	6,0	4	17	4	1,88
031-14-8G	8	G1/4	21,7	6,0	6	17	6	1,97
031-14-10G	10	G1/4	28,3	6,0	6	17	6	2,50
031-38-8G	8	G3/8	22,7	7,0	6	21	6	2,50
031-38-10G	10	G3/8	24,3	7,0	8	21	8	2,83
031-38-12G	12	G3/8	32,4	7,0	9	21	8	3,34
031-12-12G	12	G1/2	28,9	8,5	10	25	8	3,67

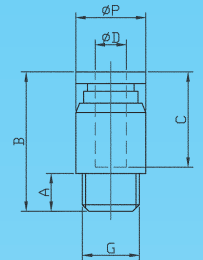

Steckverschraubungen (Typ QSF-B) - mit Innengewinde

Bestell-Nr.	Schlauch		B	G	H	DN	Euro
	Ø	Gewinde					
032-18-4	4	G1/8	24,4	11	13	3,2	1,85
032-18-6	6	G1/8	25,4	11	13	5,0	2,00
032-18-8	8	G1/8	27,7	10	13	7,0	2,06
032-18-10	10	G1/8	29,4	10	17	7,0	2,74
032-14-4	4	G1/4	27,4	14	17	3,2	2,35
032-14-6	6	G1/4	28,4	14	17	5,0	2,32
032-14-8	8	G1/4	30,7	14	17	7,0	2,41
032-14-10	10	G1/4	32,4	13	17	9,0	2,68
032-14-12	12	G1/4	36,4	15	19	10,0	3,75
032-38-6	6	G3/8	29,4	15	19	5,0	2,95
032-38-8	8	G3/8	31,7	15	19	7,0	3,19
032-38-10	10	G3/8	33,4	15	19	9,0	3,31
032-38-12	12	G3/8	39,4	18	24	10,0	3,61
032-12-10	10	G1/2	36,4	18	24	9,0	4,17
032-12-12	12	G1/2	-	-	-	-	4,47
032-12-16	16	G1/2	-	-	-	-	8,67

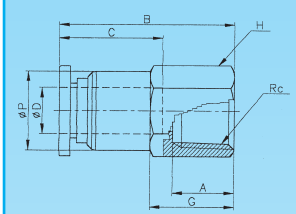

Schott-Steckverschraubungen (Typ QSSF-B) - mit Innengewinde

Bestell-Nr.	Schlauch		B	G	M	H1	H2	E max.	Euro
	Ø	Gewinde							
032SV-18-4	4	G1/8	25,1	11	M12X1,0	14	14	3,4	2,86
032SV-18-6	6	G1/8	26,3	9	M14X1,0	16	17	6,0	2,95
032SV-18-8	8	G1/8	28,9	8	M16X1,0	19	19	7,7	3,40
032SV-14-4	4	G1/4	28,1	14	M12X1,0	16	14	3,4	3,55
032SV-14-6	6	G1/4	31,3	14	M14X1,0	16	17	6,0	3,07
032SV-14-8	8	G1/4	34,9	14	M16X1,0	19	19	7,7	3,52
032SV-14-10	10	G1/4	32,3	13	M20X1,0	22	24	5,7	4,83
032SV-14-12	12	G1/4	35,4	12	M22X1,0	24	26	8,2	5,63
032SV-38-6	6	G3/8	35,9	15	M16X1,0	19	19	7,7	3,70
032SV-38-8	8	G3/8	35,9	15	M16X1,0	19	19	7,7	3,70
032SV-38-10	10	G3/8	34,3	15	M20X1,0	22	24	5,7	5,07
032SV-38-12	12	G3/8	37,4	14	M22X1,0	24	26	8,2	5,66
032SV-12-12	12	G1/2	41,4	18	M22X1,0	24	26	8,2	7,15

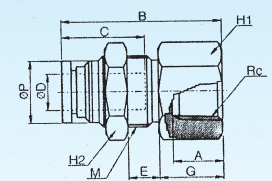

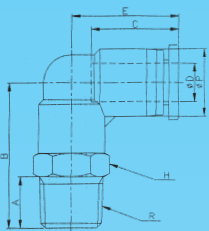

L-Steckverschraubungen (Typ QSL-B) - drehbar

Schlauch									
Bestell-Nr.	Ø	Gewinde	B	Ø P	E	A	H	DN	Euro
033-18-4	4	R1/8	17,8	9,0	17,1	8	10	4,0	1,31
033-18-6	6	R1/8	18,9	11,2	18,0	8	10	4,0	1,31
033-18-8	8	R1/8	20,3	13,6	23,6	8	10	5,5	1,52
033-18-10	10	R1/8	23,6	16,3	25,0	8	17	6,0	2,44
033-14-4	4	R1/4	20,8	9,0	17,1	11	14	4,0	1,64
033-14-6	6	R1/4	21,9	11,2	18,0	11	14	4,0	1,40
033-14-8	8	R1/4	22,8	13,6	23,6	11	14	5,5	1,58
033-14-10	10	R1/4	26,6	16,3	25,0	11	17	8,0	2,09
033-14-12	12	R1/4	28,5	19,7	32,2	11	17	8,0	2,50
033-38-6	6	R3/8	22,9	11,2	18,0	12	17	4,0	1,91
033-38-8	8	R3/8	23,8	13,6	23,6	12	17	5,5	1,91
033-38-10	10	R3/8	26,1	16,3	25,0	12	17	9,0	2,53
033-38-12	12	R3/8	28,0	19,7	32,2	12	17	9,5	2,53
033-38-14	14	R3/8	35,0	23,5	31,9	12	20	11,0	6,35
033-38-16	16	R3/8	36,0	25,6	34,0	12	20	11,0	6,41
033-12-8	8	R1/2	27,8	13,6	23,6	15	21	5,5	2,21
033-12-10	10	R1/2	29,1	16,3	25,0	15	21	9,0	2,86
033-12-12	12	R1/2	31,0	19,7	32,2	15	21	9,5	3,13
033-12-14	14	R1/2	37,5	23,5	31,9	15	21	12,0	6,50
033-12-16	16	R1/2	38,5	25,6	34,0	15	21	13,0	6,02

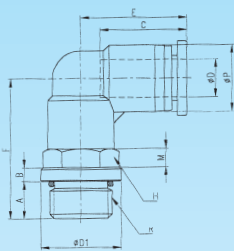

L-Steckverschraubungen (Typ QSL-G-B) - drehbar

Schlauch										
Bestell-Nr.	Ø	Gewinde	B	Ø P	E	A	H	DN	Euro	
033-5-4	4	M5	14,6	9,0	17,1	4,0	9	2,0	1,52	
033-5-6	6	M5	15,7	11,2	18,0	4,0	9	2,0	1,85	
033-18-4G	4	G1/8	14,6	9,0	17,1	5,0	13	4,0	1,31	
033-18-6G	6	G1/8	15,7	11,2	18,0	5,0	13	4,0	1,31	
033-18-8G	8	G1/8	19,6	13,6	23,6	5,0	13	5,5	1,52	
033-18-10G	10	G1/8	21,9	16,3	25,0	5,0	15	6,0	2,44	
033-14-4G	4	G1/4	15,3	9,0	17,1	6,0	16	4,0	1,67	
033-14-6G	6	G1/4	16,4	11,2	18,0	6,0	16	4,0	1,40	
033-14-8G	8	G1/4	17,8	13,6	23,6	6,0	16	5,5	1,58	
033-14-10G	10	G1/4	22,6	16,3	25,0	6,0	16	8,0	2,09	
033-14-12G	12	G1/4	24,5	19,7	32,2	6,0	16	8,0	2,50	
033-38-6G	6	G3/8	17,9	11,2	18,0	7,0	20	4,0	1,91	
033-38-8G	8	G3/8	18,8	13,6	23,6	7,0	20	5,5	1,91	
033-38-10G	10	G3/8	21,1	16,3	25,0	7,0	20	9,0	2,53	
033-38-12G	12	G3/8	23,0	19,7	32,2	7,0	20	9,5	2,53	
033-38-14G	14	G3/8	30,5	23,5	31,9	7,0	20	11,5	6,35	
033-38-15G	15	G3/8	Sonder-Ausführung komplett Kunststoff schwarz							11,80
033-38-16G	16	G3/8	31,5	25,6	34,0	7,0	20	11,5	6,41	
033-12-8G	8	G1/2	20,8	13,6	23,6	8,5	24	5,5	2,29	
033-12-10G	10	G1/2	22,6	16,3	25,0	8,5	24	9,0	2,86	
033-12-12G	12	G1/2	24,5	19,7	32,2	8,5	24	9,5	3,13	
033-12-14G	14	G1/2	26,0	23,5	31,9	8,5	24	12,0	6,50	
033-12-15G	15	G1/2	Sonder-Ausführung komplett Kunststoff schwarz							13,11
033-12-16G	16	G1/2	27,0	25,6	34,0	8,5	24	13,0	6,02	
033-12-18G	18	G1/2	Sonder-Ausführung komplett Kunststoff schwarz							13,83
033-12-22G	22	G1/2	Sonder-Ausführung komplett Kunststoff schwarz							17,76
033-34-22G	22	G3/4	Sonder-Ausführung komplett Kunststoff schwarz							20,32
033-34-28G	28	G3/4	Sonder-Ausführung komplett Kunststoff schwarz							48,87
033-10-28G	28	G1	Sonder-Ausführung komplett Kunststoff schwarz							49,57

L-Steckverschraubungen (Typ QSSL-B) - drehbar - lang

Bestell-Nr.	Schlauch		B	Ø P	E	A	H	DN	Euro
	Ø	Gewinde							
033LL-18-4	4	R1/8	33,50	9,0	17,1	8	10	4,0	2,56
033LL-18-6	6	R1/8	35,10	11,2	18,0	8	10	4,0	2,86
033LL-18-8	8	R1/8	40,30	13,6	23,6	8	10	5,5	3,07
033LL-18-10	10	R1/8	50,85	16,3	25,0	8	17	6,0	3,90
033LL-14-4	4	R1/4	36,50	9,0	17,1	11	14	4,0	2,86
033LL-14-6	6	R1/4	38,10	11,2	18,0	11	14	4,0	2,95
033LL-14-8	8	R1/4	42,80	13,6	23,6	11	14	5,5	3,16
033LL-14-10	10	R1/4	53,85	16,3	25,0	11	17	8,0	3,90
033LL-14-12	12	R1/4	55,55	19,7	32,2	11	17	8,0	5,75
033LL-38-6	6	R3/8	39,10	11,2	18,0	12	17	4,0	3,78
033LL-38-8	8	R3/8	43,80	13,6	23,6	12	17	5,5	3,73
033LL-38-10	10	R3/8	53,35	16,3	25,0	12	17	9,0	3,99
033LL-38-12	12	R3/8	55,05	19,7	32,2	12	17	9,5	5,72
033LL-12-10	10	R1/2	56,35	16,3	25,0	15	21	9,0	6,11
033LL-12-12	12	R1/2	58,05	19,7	32,2	15	21	9,5	5,96
033LL-12-16	16	R1/2	-	-	-	-	-	-	13,17

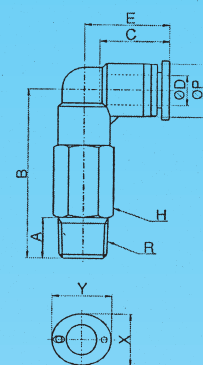

L-Steckverschraubungen (Typ QSSL-G-B) - drehbar - lang

Bestell-Nr.	Schlauch		B	Ø P	E	A	H	DN	Euro
	Ø	Gewinde							
033LL-5-4	4	M5	30,30	9,0	17,1	4	9	2,0	2,71
033LL-5-6	6	M5	31,90	11,2	18,0	4	9	2,0	2,89
033LL-18-4G	4	G1/8	30,30	9,0	17,1	5,0	13	4,0	2,56
033LL-18-6G	6	G1/8	31,90	11,2	18,0	5,0	13	4,0	2,86
033LL-18-8G	8	G1/8	39,60	13,6	23,6	5,0	13	5,5	3,07
033LL-18-10G	10	G1/8	49,15	16,3	25,0	5,0	15	6,0	3,90
033LL-14-4G	4	G1/4	31,00	9,0	17,1	6,0	16	4,0	2,86
033LL-14-6G	6	G1/4	32,60	11,2	18,0	6,0	16	4,0	2,95
033LL-14-8G	8	G1/4	37,80	13,6	23,6	6,0	16	5,5	3,16
033LL-14-10G	10	G1/4	49,85	16,3	25,0	6,0	16	8,0	3,90
033LL-14-12G	12	G1/4	51,55	19,7	32,2	6,0	16	8,0	5,75
033LL-38-6G	6	G3/8	34,10	11,2	18,0	7,0	20	4,0	3,78
033LL-38-8G	8	G3/8	38,80	13,6	23,6	7,0	20	5,5	3,73
033LL-38-10G	10	G3/8	48,35	16,3	25,0	7,0	20	9,0	3,99
033LL-38-12G	12	G3/8	50,05	19,7	32,2	7,0	20	9,5	5,72
033LL-12-10G	10	G1/2	49,85	16,3	25,0	8,5	24	9,0	6,11
033LL-12-12G	12	G1/2	51,55	19,7	32,2	8,5	24	9,5	5,96
033LL-12-16G	16	G1/2	-	-	-	-	-	-	13,17

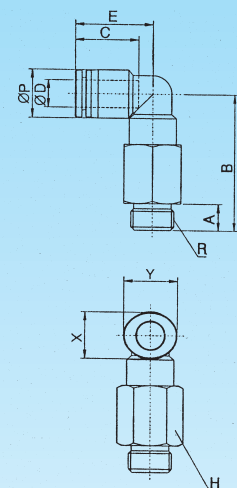
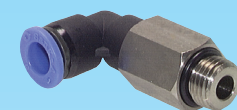

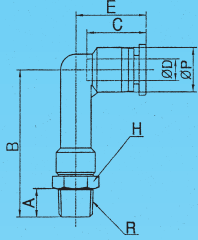

L-Steckverschraubungen (Typ QSLK-B) - drehbar - Körper lang

Schlauch								
Bestell-Nr.	Ø	Gewinde	B	Ø P	E	A	H	Euro
033LK-18-4	4	R1/8	30,3	9,0	17,1	8	10	1,67
033LK-18-6	6	R1/8	31,4	11,2	18,0	8	11	1,67
033LK-18-8	8	R1/8	35,3	13,6	23,6	8	13	1,97
033LK-18-10	10	R1/8	44,8	16,3	25,0	8	17	3,31
033LK-14-4	4	R1/4	33,3	9,0	17,1	11	14	2,18
033LK-14-6	6	R1/4	34,4	11,2	18,0	11	14	1,79
033LK-14-8	8	R1/4	37,8	13,6	23,6	11	14	2,00
033LK-14-10	10	R1/4	47,8	16,3	25,0	11	17	2,68
033LK-14-12	12	R1/4	49,7	19,7	32,2	11	19	3,37
033LK-38-6	6	R3/8	35,4	11,2	18,0	12	17	2,71
033LK-38-8	8	R3/8	38,8	13,6	23,6	12	17	2,53
033LK-38-10	10	R3/8	47,3	16,3	25,0	12	17	3,25
033LK-38-12	12	R3/8	49,2	19,7	32,2	12	19	3,25
033LK-12-10	10	R1/2	50,3	16,3	25,0	15	21	4,05
033LK-12-12	12	R1/2	52,2	19,7	32,2	15	21	4,17

L-Steckverschraubungen (Typ QSLK-G-B) - drehbar - Körper lang

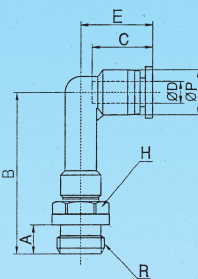

Schlauch								
Bestell-Nr.	Ø	Gewinde	B	Ø P	E	A	H	Euro
033LK-5-4	4	M5	27,1	9,0	17,1	4,0	9	1,97
033LK-5-6	6	M5	28,2	11,2	18,0	4,0	11	2,26
033LK-18-4G	4	G1/8	27,1	9,0	17,1	5,0	13	1,67
033LK-18-6G	6	G1/8	28,2	11,2	18,0	5,0	13	1,67
033LK-18-8G	8	G1/8	34,6	13,6	23,6	5,0	13	1,97
033LK-18-10G	10	G1/8	43,1	16,3	25,0	5,0	17	3,31
033LK-14-4G	4	G1/4	27,8	9,0	17,1	6,0	16	2,18
033LK-14-6G	6	G1/4	28,9	11,2	18,0	6,0	16	1,79
033LK-14-8G	8	G1/4	32,8	13,6	23,6	6,0	16	2,00
033LK-14-10G	10	G1/4	43,8	16,3	25,0	6,0	17	2,68
033LK-14-12G	12	G1/4	45,7	19,7	32,2	6,0	19	3,37
033LK-38-6G	6	G3/8	30,4	11,2	18,0	7,0	20	2,71
033LK-38-8G	8	G3/8	33,8	13,6	23,6	7,0	20	2,53
033LK-38-10G	10	G3/8	42,3	16,3	25,0	7,0	20	3,25
033LK-38-12G	12	G3/8	44,2	19,7	32,2	7,0	20	3,25
033LK-12-10G	10	G1/2	43,8	16,3	25,0	8,5	24	4,05
033LK-12-12G	12	G1/2	45,7	19,7	32,2	8,5	24	4,17

L-Steckverschraubungen (Typ QSLF-B) - drehbar

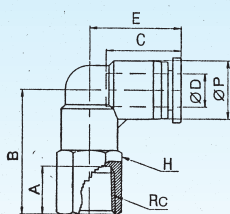

Schlauch									
Bestell-Nr.	Ø	Gewinde	B	Ø P	E	A	H	DN	Euro
033IG-5-4	4	M5	14,6	9,0	5	17,1	9	3,5	2,92
033IG-5-6	6	M5	15,7	11,2	5	18,0	9	3,5	2,98
033IG-18-4G	4	G1/8	18,6	9,0	9	17,1	13	4,0	2,41
033IG-18-6G	6	G1/8	19,7	11,2	9	18,0	13	4,0	2,44
033IG-18-8G	8	G1/8	21,7	13,6	9	23,6	13	5,5	2,83
033IG-14-4G	4	G1/4	21,6	9,0	12	17,1	16	4,0	2,62
033IG-14-6G	6	G1/4	22,7	11,2	12	18,0	16	4,0	2,62
033IG-14-8G	8	G1/4	24,7	13,6	12	23,6	16	5,5	3,01
033IG-14-10G	10	G1/4	26,0	16,3	12	25,0	16	9,0	3,84
033IG-38-6G	6	G3/8	23,7	11,2	13	18,0	19	4,0	3,25
033IG-38-8G	8	G3/8	25,7	13,6	13	23,6	19	5,5	3,13
033IG-38-10G	10	G3/8	27,0	16,3	13	25,0	19	9,0	3,93
033IG-12-10G	10	G1/2	30,0	16,3	16	25,0	24	9,0	4,59

L-Steckverschraubungen (Typ QSW-B) - drehbar

Bestell-Nr.	Schlauch		G	Ø P	B	E	A	H	Euro
	Ø	Gewinde							
033W-18-4	4	R1/8	31,30	9,0	16,3	17,1	8	10	1,52
033W-18-6	6	R1/8	33,30	11,2	16,9	18,0	8	10	1,52
033W-18-8	8	R1/8	38,61	13,6	17,5	23,6	8	10	1,76
033W-18-10	10	R1/8	42,65	16,3	19,6	25,0	8	17	2,83
033W-14-4	4	R1/4	34,30	9,0	19,3	17,1	11	14	1,88
033W-14-6	6	R1/4	36,30	11,2	19,9	18,0	11	14	1,64
033W-14-8	8	R1/4	41,11	13,6	20,0	23,6	11	14	1,79
033W-14-10	10	R1/4	45,65	16,3	22,6	25,0	11	17	2,41
033W-14-12	12	R1/4	53,41	19,7	24,1	32,2	11	17	2,86
033W-38-6	6	R3/8	37,30	11,2	20,9	18,0	12	17	2,18
033W-38-8	8	R3/8	42,11	13,6	21,0	23,6	12	17	2,18
033W-38-10	10	R3/8	45,15	16,3	22,1	25,0	12	17	2,92
033W-38-12	12	R3/8	52,91	19,7	23,6	32,2	12	17	2,92
033W-12-8	8	R1/2	46,11	13,6	25,0	23,6	15	21	2,62
033W-12-10	10	R1/2	48,15	16,3	25,1	25,0	15	21	3,31
033W-12-12	12	R1/2	55,91	19,7	26,6	32,2	15	21	3,58

L-Steckverschraubungen (Typ QSW-G-B) - drehbar

Bestell-Nr.	Schlauch		G	Ø P	B	E	A	H	Euro
	Ø	Gewinde							
033W-5-4	4	M5	28,10	9,0	13,1	17,1	4,0	9	1,76
033W-5-6	6	M5	30,10	11,2	13,7	18,0	4,0	9	2,12
033W-18-4G	4	G1/8	28,10	9,0	13,1	17,1	5,0	13	1,52
033W-18-6G	6	G1/8	30,10	11,2	13,7	18,0	5,0	13	1,52
033W-18-8G	8	G1/8	37,91	13,6	16,8	23,6	5,0	13	1,76
033W-18-10G	10	G1/8	40,95	16,3	17,9	25,0	5,0	15	2,83
033W-14-4G	4	G1/4	28,80	9,0	13,8	17,1	6,0	16	1,88
033W-14-6G	6	G1/4	30,80	11,2	14,4	18,0	6,0	16	1,64
033W-14-8G	8	G1/4	36,11	13,6	15,0	23,6	6,0	16	1,79
033W-14-10G	10	G1/4	41,65	16,3	18,6	25,0	6,0	16	2,41
033W-14-12G	12	G1/4	49,41	19,7	20,1	32,2	6,0	16	2,86
033W-38-6G	6	G3/8	32,30	11,2	15,9	18,0	7,0	20	2,18
033W-38-8G	8	G3/8	37,11	13,6	16,0	23,6	7,0	20	2,18
033W-38-10G	10	G3/8	40,15	16,3	17,1	25,0	7,0	20	2,92
033W-38-12G	12	G3/8	47,91	19,7	18,6	32,2	7,0	20	2,92
033W-12-8G	8	G1/2	39,11	13,6	18,0	23,6	8,5	24	2,62
033W-12-10G	10	G1/2	41,65	16,3	18,6	25,0	8,5	24	3,31
033W-12-12G	12	G1/2	49,41	19,7	20,1	32,2	8,5	24	3,58

T-Steckverschraubungen (Typ QSTFF-B) - drehbar - mit Innengewinde

Bestell-Nr.	Schlauch		B	Ø P	E	F	H	DN	Euro
	Ø	Gewinde							
034IG-5-4	4	M5	16,6	9,0	17,1	9,8	9	3,5	3,34
034IG-5-6	6	M5	17,7	11,2	18,0	9,8	9	3,5	3,49
034IG-18-4G	4	G1/8	20,6	9,0	17,1	13,8	13	4,0	2,89
034IG-18-6G	6	G1/8	21,7	11,2	18,0	13,8	13	4,0	2,95
034IG-18-8G	8	G1/8	24,9	13,6	23,6	14,4	13	5,5	3,34
034IG-14-4G	4	G1/4	23,6	9,0	17,1	16,8	16	4,0	2,98
034IG-14-6G	6	G1/4	24,7	11,2	18,0	16,8	16	4,0	3,19
034IG-14-8G	8	G1/4	27,9	13,6	23,6	17,4	16	5,5	3,64
034IG-14-10G	10	G1/4	28,2	16,3	25,0	16,9	16	9,0	4,59
034IG-38-6G	6	G3/8	25,7	11,2	18,0	17,8	19	4,0	3,67
034IG-38-8G	8	G3/8	28,9	13,6	23,6	18,4	19	5,5	3,73
034IG-38-10G	10	G3/8	29,2	16,3	25,0	17,9	19	9,0	4,65
034IG-12-10G	10	G1/2	32,2	16,3	25,0	20,9	24	9,0	5,51

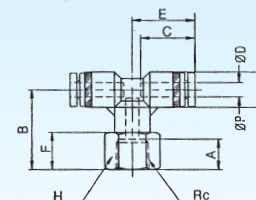
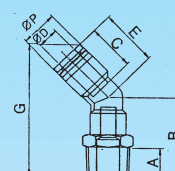
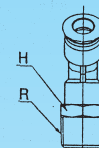
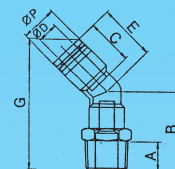
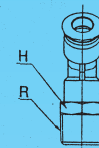

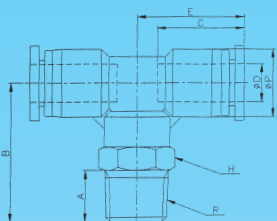

TE-Steckverschraubungen (Typ QST-B) - drehbar

Schlauch								
Bestell-Nr.	Ø	Gewinde	B	Ø P	E	A	H	Euro
034-18-4	4	R1/8	19,80	9,0	17,1	8	10	2,15
034-18-6	6	R1/8	20,90	11,2	18,0	8	10	2,32
034-18-8	8	R1/8	23,50	13,6	23,6	8	10	2,56
034-18-10	10	R1/8	25,80	16,3	25,0	8	17	3,22
034-14-4	4	R1/4	22,80	9,0	17,1	11	14	2,38
034-14-6	6	R1/4	23,90	11,2	18,0	11	14	2,41
034-14-8	8	R1/4	26,00	13,6	23,6	11	14	2,59
034-14-10	10	R1/4	28,80	16,3	25,0	11	17	3,28
034-14-12	12	R1/4	30,50	19,7	32,2	11	17	3,84
034-38-6	6	R3/8	24,90	11,2	18,0	12	17	3,01
034-38-8	8	R3/8	27,00	13,6	23,6	12	17	2,89
034-38-10	10	R3/8	28,30	16,3	25,0	12	17	3,49
034-38-12	12	R3/8	30,00	19,7	32,2	12	17	3,78
034-38-14	14	R3/8	37,45	23,5	31,9	12	20	8,17
034-12-8	8	R1/2	31,00	13,6	23,6	15	21	3,52
034-12-10	10	R1/2	31,30	16,3	25,0	15	21	4,05
034-12-12	12	R1/2	33,00	19,7	32,2	15	21	4,23
034-12-14	14	R1/2	39,95	23,5	31,9	15	21	8,28
034-12-16	16	R1/2	41,00	25,6	34,0	15	21	7,63

TE-Steckverschraubungen (Typ QST-G-B) - drehbar

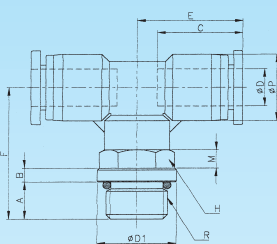

Schlauch								
Bestell-Nr.	Ø	Gewinde	B	Ø P	E	A	H	Euro
034-5-4	4	M5	16,60	9,0	17,1	4,0	9	2,26
034-5-6	6	M5	17,70	11,2	18,0	4,0	9	2,59
034-18-4G	4	G1/8	16,60	9,0	17,1	5,0	13	2,15
034-18-6G	6	G1/8	17,70	11,2	18,0	5,0	13	2,32
034-18-8G	8	G1/8	22,80	13,6	23,6	5,0	13	2,56
034-18-10G	10	G1/8	24,10	16,3	25,0	5,0	15	3,22
034-14-4G	4	G1/4	17,30	9,0	17,1	6,0	16	2,38
034-14-6G	6	G1/4	18,40	11,2	18,0	6,0	16	2,41
034-14-8G	8	G1/4	21,00	13,6	23,6	6,0	16	2,59
034-14-10G	10	G1/4	24,80	16,3	25,0	6,0	16	3,28
034-14-12G	12	G1/4	26,50	19,7	32,2	6,0	16	3,84
034-38-6G	6	G3/8	19,90	11,2	18,0	7,0	20	3,01
034-38-8G	8	G3/8	22,00	13,6	23,6	7,0	20	2,89
034-38-10G	10	G3/8	23,30	16,3	25,0	7,0	20	3,49
034-38-12G	12	G3/8	25,00	19,7	32,2	7,0	20	3,78
034-38-14G	14	G3/8	32,95	23,5	31,9	7,0	20	8,17
034-12-8G	8	G1/2	24,00	13,6	23,6	8,5	24	3,52
034-12-10G	10	G1/2	24,80	16,3	25,0	8,5	24	4,05
034-12-12G	12	G1/2	26,50	19,7	32,2	8,5	24	4,23
034-12-14G	14	G1/2	28,45	23,5	31,9	8,5	24	8,28
034-12-15G	15	G1/2	Sonder-Ausführung komplett Kunststoff schwarz					15,50
034-12-16G	16	G1/2	29,50	25,6	34,0	8,5	24	7,63
034-12-18G	18	G1/2	Sonder-Ausführung komplett Kunststoff schwarz					18,06
034-12-22G	22	G1/2	Sonder-Ausführung komplett Kunststoff schwarz					19,76
034-34-22G	22	G3/4	Sonder-Ausführung komplett Kunststoff schwarz					22,77
034-34-28G	28	G3/4	Sonder-Ausführung komplett Kunststoff schwarz					53,64
034-10-28G	28	G1	Sonder-Ausführung komplett Kunststoff schwarz					54,18

LE-Steckverschraubungen (Typ QSTL-B) - drehbar

Bestell-Nr.	Schlauch						Euro
	Ø	Gewinde	B	E	A	H	
035-18-4	4	R1/8	17,8	17,1	8	10	2,59
035-18-6	6	R1/8	18,9	19,0	8	10	2,80
035-18-8	8	R1/8	20,3	23,6	8	10	3,16
035-18-10	10	R1/8	23,6	25,0	8	17	4,14
035-14-4	4	R1/4	20,8	17,1	11	14	2,89
035-14-6	6	R1/4	21,9	19,0	11	14	2,95
035-14-8	8	R1/4	22,8	23,6	11	14	3,25
035-14-10	10	R1/4	26,6	25,0	11	17	3,99
035-14-12	12	R1/4	28,5	32,2	11	17	4,95
035-38-6	6	R3/8	22,9	19,0	12	17	3,64
035-38-8	8	R3/8	23,8	23,6	12	17	3,37
035-38-10	10	R3/8	26,1	25,0	12	17	4,20
035-38-12	12	R3/8	28,0	32,2	12	17	4,77
035-38-14	14	R3/8	35,0	31,9	12	20	8,25
035-12-8	8	R1/2	27,8	23,6	15	21	4,20
035-12-10	10	R1/2	29,1	25,0	15	21	4,92
035-12-12	12	R1/2	31,0	32,2	15	21	5,01
035-12-14	14	R1/2	37,5	31,9	15	21	8,55
035-12-16	16	R1/2	38,5	34,0	15	21	9,12

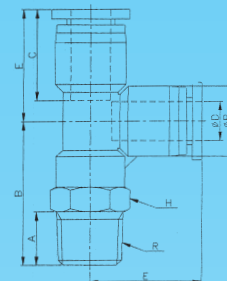

LE-Steckverschraubungen (Typ QSTL-G-B) - drehbar

Bestell-Nr.	Schlauch						Euro
	Ø	Gewinde	B	E	A	H	
035-5-4	4	M5	14,6	17,1	4,0	9	2,89
035-5-6	6	M5	15,7	19,0	4,0	9	3,16
035-18-4G	4	G1/8	14,6	17,1	5,0	13	2,59
035-18-6G	6	G1/8	15,7	19,0	5,0	13	2,80
035-18-8G	8	G1/8	19,6	23,6	5,0	13	3,16
035-18-10G	10	G1/8	21,9	25,0	5,0	15	4,14
035-14-4G	4	G1/4	15,3	17,1	6,0	16	2,89
035-14-6G	6	G1/4	16,4	19,0	6,0	16	2,95
035-14-8G	8	G1/4	17,8	23,6	6,0	16	3,25
035-14-10G	10	G1/4	22,6	25,0	6,0	16	3,99
035-14-12G	12	G1/4	24,5	32,2	6,0	16	4,95
035-38-6G	6	G3/8	17,9	19,0	7,0	20	3,64
035-38-8G	8	G3/8	18,8	23,6	7,0	20	3,37
035-38-10G	10	G3/8	21,1	25,0	7,0	20	4,20
035-38-12G	12	G3/8	23,0	32,2	7,0	20	4,77
035-12-10G	10	G1/2	22,6	25,0	8,5	24	4,92
035-12-12G	12	G1/2	24,5	32,2	8,5	24	5,04
035-12-14G	14	G1/2	26,0	31,9	8,5	24	8,55
035-12-15G	15	G1/2	Sonder-Ausführung komplett Kunststoff schwarz				16,09
035-12-16G	16	G1/2	27,0	34,0	8,5	24	9,12
035-12-18G	18	G1/2	Sonder-Ausführung komplett Kunststoff schwarz				17,61
035-12-22G	22	G1/2	Sonder-Ausführung komplett Kunststoff schwarz				22,50
035-34-22G	22	G3/4	Sonder-Ausführung komplett Kunststoff schwarz				25,06
035-34-28G	28	G3/4	Sonder-Ausführung komplett Kunststoff schwarz				53,64
035-10-28G	28	G1	Sonder-Ausführung komplett Kunststoff schwarz				54,18

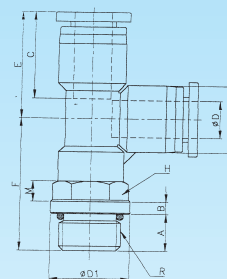

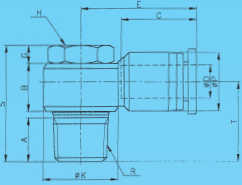

L-Steckverschraubungen (Typ QSLV-B) - drehbar

Schlauch								Euro
Bestell-Nr.	Ø	Gewinde	B	Ø P	E	A	H	
036-18-4	4	R1/8	26,5	9,0	21,5	8	13	2,38
036-18-6	6	R1/8	26,5	11,2	22,5	8	13	2,41
036-18-8	8	R1/8	26,5	13,6	25,6	8	13	3,07
036-14-6	6	R1/4	34,0	11,2	25,0	11	17	2,86
036-14-8	8	R1/4	34,0	13,6	28,1	11	17	3,25
036-14-10	10	R1/4	34,0	16,3	28,9	11	17	3,81
036-14-12	12	R1/4	-	-	-	-	-	4,98
036-38-8	8	R3/8	39,8	13,6	29,8	12	21	3,78
036-38-10	10	R3/8	39,8	16,3	30,6	12	21	4,08
036-38-12	12	R3/8	39,8	19,7	35,9	12	21	5,07
036-12-10	10	R1/2	44,8	16,3	32,9	15	24	4,74
036-12-12	12	R1/2	44,8	19,7	38,2	15	24	5,19

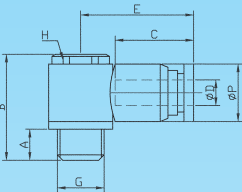

L-Steckverschraubungen (Typ QSLV-G-B) - drehbar

Schlauch								Euro
Bestell-Nr.	Ø	Gewinde	B	Ø P	E	A	H	
036-5-4	4	M5	17,8	9,0	19,5	3,5	8	2,80
036-5-6	6	M5	17,8	11,2	20,5	3,5	8	2,95
036-18-4G	4	G1/8	22,0	9,0	21,5	5,0	13	2,53
036-18-6G	6	G1/8	22,0	11,2	22,5	5,0	13	2,59
036-18-8G	8	G1/8	22,0	13,6	25,6	5,0	13	3,28
036-14-6G	6	G1/4	27,0	11,2	25,0	6,0	16	3,07
036-14-8G	8	G1/4	27,0	13,6	28,1	6,0	16	3,52
036-14-10G	10	G1/4	27,0	16,3	28,9	6,0	16	4,08
036-38-8G	8	G3/8	32,0	13,6	29,8	7,0	20	4,05
036-38-10G	10	G3/8	32,0	16,3	30,6	7,0	20	4,23
036-38-12G	12	G3/8	32,0	19,7	35,9	7,0	20	5,45
036-12-12G	12	G1/2	35,5	19,7	38,2	8,5	24	5,57

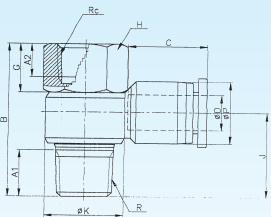

L-Steckverschraubungen (Typ QSTF-G-B) - drehbar

Schlauch		Außen- gewinde	Innen- gewinde	B	C	E	H	Euro
Bestell-Nr.	Ø							
037-18-4	4	R1/8	G1/8	34,5	14,5	21,5	13	3,34
037-18-6	6	R1/8	G1/8	34,5	15,5	22,5	13	3,43
037-18-8	8	R1/8	G1/8	34,5	17,8	25,6	13	3,61
037-14-6	6	R1/4	G1/4	44,5	15,5	25,0	17	3,84
037-14-8	8	R1/4	G1/4	44,5	17,8	28,1	17	3,96
037-14-10	10	R1/4	G1/4	44,5	19,4	28,9	17	4,17
037-38-8	8	R3/8	G3/8	50,8	17,8	29,8	21	5,63
037-38-10	10	R3/8	G3/8	50,8	19,4	30,6	21	5,72
037-38-12	12	R3/8	G3/8	50,8	22,4	35,9	21	5,81
037-12-12	12	R1/2	G1/2	58,8	22,4	38,2	24	6,50

L-Steckverschraubungen (Typ QSTF-G-B) - drehbar

Bestell-Nr.	Schlauch						Euro
	Ø	Gewinde	B	C	E	H	
037-5-4	4	M5	-	-	-	-	3,07
037-5-6	6	M5	-	-	-	-	3,16
037-18-4G	4	G1/8	30,0	14,5	21,5	13	3,70
037-18-6G	6	G1/8	30,0	15,5	22,5	13	3,81
037-18-8G	8	G1/8	30,0	17,8	25,6	13	3,93
037-14-6G	6	G1/4	37,5	15,5	25,0	16	4,20
037-14-8G	8	G1/4	37,5	17,8	28,1	16	4,35
037-14-10G	10	G1/4	37,5	19,4	28,9	16	4,62
037-38-8G	8	G3/8	43,0	17,8	29,8	20	6,17
037-38-10G	10	G3/8	43,0	19,4	30,6	20	6,26
037-38-12G	12	G3/8	43,0	22,4	35,9	20	6,38
037-12-12G	12	G1/2	49,5	22,4	38,2	24	7,15

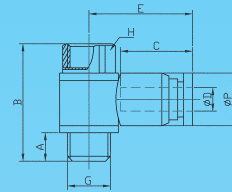

L-Steckverschraubungen (Typ QSLV-B) - drehbar - mit Innensechskant

Bestell-Nr.	Schlauch							Euro
	Ø	Gewinde	B	C	E	H	A	
037IS-18-4	4	R1/8	30,0	14,5	21,5	8	6	3,37
037IS-18-6	6	R1/8	30,0	15,5	22,5	8	6	3,67
037IS-18-8	8	R1/8	30,0	17,8	25,6	8	6	3,78
037IS-14-6	6	R1/4	38,0	15,5	25,0	11	8	3,78
037IS-14-8	8	R1/4	38,0	17,8	28,1	11	8	4,11
037IS-14-10	10	R1/4	38,0	19,4	28,9	11	8	5,36
037IS-38-8	8	R3/8	42,8	17,8	29,8	12	10	5,45
037IS-38-10	10	R3/8	42,8	19,4	30,6	12	10	5,69
037IS-38-12	12	R3/8	42,8	22,4	35,9	12	10	6,56
037IS-12-10	10	R1/2	50,8	19,4	32,9	15	12	6,20
037IS-12-12	12	R1/2	50,8	22,4	38,2	15	12	6,85

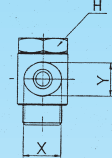
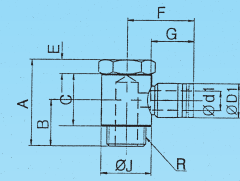

L-Steckverschraubungen (Typ QSLV-G-B) - drehbar - mit Innensechskant

Bestell-Nr.	Schlauch							Euro
	Ø	Gewinde	B	C	E	H	A	
037IS-5-4	4	M5	-	-	-	-	-	3,55
037IS-5-6	6	M5	19,3	15,5	20,5	3,5	3	3,64
037IS-18-4G	4	G1/8	25,5	14,5	21,5	5,0	6	3,78
037IS-18-6G	6	G1/8	25,5	15,5	22,5	5,0	6	3,90
037IS-18-8G	8	G1/8	25,5	17,8	25,6	5,0	6	4,05
037IS-14-6G	6	G1/4	31,0	15,5	25,0	6,0	8	4,05
037IS-14-8G	8	G1/4	31,0	17,8	28,1	6,0	8	4,38
037IS-14-10G	10	G1/4	31,0	19,4	28,9	6,0	8	5,66
037IS-38-8G	8	G3/8	35,0	17,8	29,8	7,0	10	5,81
037IS-38-10G	10	G3/8	35,0	19,4	30,6	7,0	10	5,99
037IS-38-12G	12	G3/8	35,0	22,4	35,9	7,0	10	6,94
037IS-12-12G	12	G1/2	41,5	22,4	38,2	8,5	12	7,24

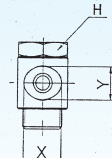
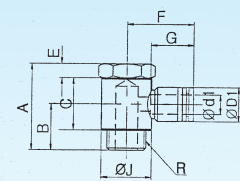

L-Ringstücke (Typ QSVLK-B) - mit einem Steckanschluss

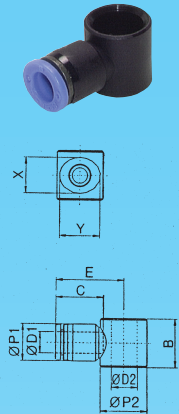

Bestell-Nr.	Schlauch für		B	E	Ø P2	Ø P1	Euro
	Ø D1	Gewinde					
037L-18-4	4	G1/8	17	19,0	15,0	10,4	0,80
037L-18-6	6	G1/8	17	19,8	15,0	12,4	0,86
037L-18-8	8	G1/8	17	21,6	15,0	14,4	0,92
037L-14-6	6	G1/4	19	20,9	18,0	12,4	0,86
037L-14-8	8	G1/4	19	21,6	18,0	14,4	0,92
037L-14-10	10	G1/4	19	24,0	18,0	17,6	1,13
037L-38-8	8	G3/8	22	24,0	21,5	14,4	0,98
037L-38-10	10	G3/8	22	25,5	21,5	17,6	1,16
037L-38-12	12	G3/8	22	28,0	21,5	21,2	1,22
037L-12-12	12	G1/2	24	30,3	26,0	21,2	1,28

T-Ringstücke (Typ QSVTK-B) - mit 2 Steckanschlüssen

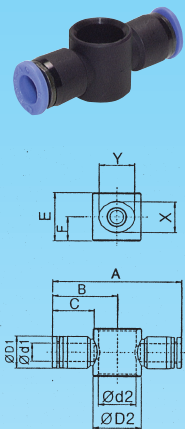

Bestell-Nr.	Schlauch für		A	E	Ø D1	Ø D2	Euro
	Ø d1	Gewinde					
037T-18-4	4	G1/8	38,0	17	10,4	15,0	1,46
037T-18-6	6	G1/8	39,9	17	12,4	15,0	1,46
037T-18-8	8	G1/8	43,2	17	14,4	15,0	1,55
037T-14-6	6	G1/4	41,8	19	12,4	18,0	1,49
037T-14-8	8	G1/4	43,2	19	14,4	18,0	1,61
037T-14-10	10	G1/4	48,0	19	17,6	18,0	2,00
037T-38-8	8	G3/8	48,0	22	14,4	21,5	1,61
037T-38-10	10	G3/8	51,0	22	17,6	21,5	2,03
037T-38-12	12	G3/8	56,0	22	21,2	21,5	2,09
037T-12-12	12	G1/2	60,0	24	21,2	26,0	2,15

Hohlschraube 1-fach (Typ QSVVT-B) - Messing vernickelt

Kombinierbar mit 037L... & 037T... siehe oben

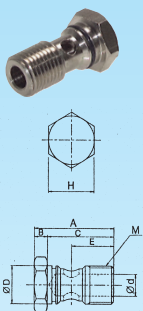

Bestell-Nr.	Gewinde	A	B	E	Ø d	Ø D	Euro
037H-181	G1/8	26,5	4	14,0	5,0	9,7	1,85
037H-141	G1/4	32,0	5	17,5	7,0	13,1	2,41
037H-381	G3/8	36,5	6	19,5	9,5	16,6	3,43
037H-121	G1/2	40,5	6	22,5	11,5	20,9	4,65

Pro 1-facher Hohlschraube werden 2 O-Ringe benötigt - siehe Seite B16. Bitte extra bestellen!

Hohlschraube 2-fach (Typ QSVVT-B) - Messing vernickelt

Kombinierbar mit 037L... & 037T... siehe oben

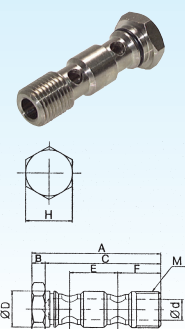

Bestell-Nr.	Gewinde	A	B	E	F	Ø d	Ø D	Euro
037H-182	G1/8	43,5	4	17	14,0	5,0	9,7	2,50
037H-142	G1/4	51,0	5	19	17,5	7,0	13,1	3,31
037H-382	G3/8	58,5	6	22	19,5	9,5	16,6	4,89
037H-122	G1/2	64,5	6	24	22,5	11,5	20,9	6,65

Pro 2-facher Hohlschraube werden 3 O-Ringe benötigt - siehe Seite B16. Bitte extra bestellen!

Hohlschraube 3-fach (Typ QSVVT-B) - Messing vernickelt

Kombinierbar mit 037L... & 037T... siehe Seite B15

Bestell-Nr.	Gewinde	A	B	E	F	G	Ø d	Ø D	Euro
037H-183	G1/8	60,5	4	17	17	14,0	5,0	9,7	3,43
037H-143	G1/4	70,0	5	19	19	17,5	7,0	13,1	4,56
037H-383	G3/8	80,5	6	22	22	19,5	9,5	16,6	6,59
037H-123	G1/2	88,5	6	24	24	22,5	11,5	20,9	9,06

Pro 3-facher Hohlschraube werden 4 O-Ringe benötigt. Bitte extra bestellen!

O-Ring für Hohlschrauben (Typ QSVOR-B)

Bestell-Nr.	Ø D1	Ø d	Euro
037-O-18	8	1,5	0,12
037-O-14	12	1,5	0,12
037-O-38	15,5	1,5	0,15
037-O-12	19,5	1,5	0,15

Y-Steckverschraubungen (Typ QSYLV-B) - drehbar - mit Außensechskant

Bestell-Nr.	Schlauch		B	E	C	A	H	Euro
	Ø	Gewinde						
038-18-6	6	R1/8	26,5	22,0	15,5	8	13	3,73
038-14-8	8	R1/4	34,0	28,1	17,8	11	17	4,71
038-38-10	10	R3/8	39,8	29,6	19,4	12	21	6,20
038-12-12	12	R1/2	44,8	34,9	22,4	15	24	7,75

Y-Steckverschraubungen (Typ QSYLV-G-B)

- drehbar - mit Außensechskant

Bestell-Nr.	Schlauch		B	E	C	A	H	Euro
	Ø	Gewinde						
038-5-4	4	M5	17,8	18,6	14,5	3,5	8	4,20
038-18-6G	6	G1/8	22,0	22,0	15,5	5,0	13	3,73
038-14-8G	8	G1/4	27,0	28,1	17,8	6,0	16	4,71
038-38-10G	10	G3/8	32,0	29,6	19,4	7,0	20	5,96
038-12-12G	12	G1/2	35,5	34,9	22,4	8,5	24	7,75

Y-Steckverschraubungen (Typ QSYTF-B)

Bestell-Nr.	Schlauch		B	E	C	A1	H	Euro
	Ø	Gewinde						
039-18-6	6	R1/8	34,5	22,0	15,5	8	13	4,14
039-14-8	8	R1/4	44,5	28,1	17,8	11	17	5,19
039-38-10	10	R3/8	50,8	29,6	19,4	12	21	6,94
039-12-12	12	R1/2	58,8	34,9	22,4	15	24	8,43

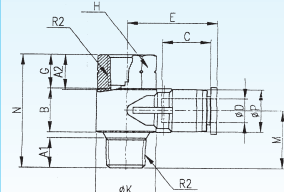
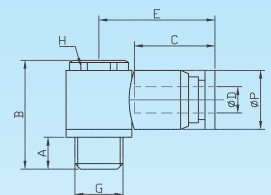
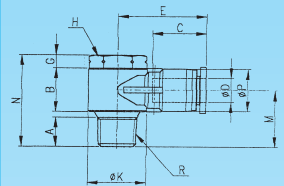
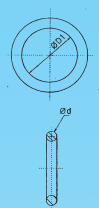
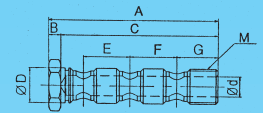

Y-Steckverschraubungen (Typ QSYTF-G-B) - drehbar

Schlauch								
Bestell-Nr.	Ø	Gewinde	B	E	C	A1	H	Euro
039-5-4	4	M5	20,8	18,6	14,5	3,5	8	4,20
039-18-6G	6	G1/8	30,0	22,0	15,5	5,0	13	4,14
039-14-8G	8	G1/4	37,5	28,1	17,8	6,0	16	5,19
039-38-10G	10	G3/8	43,0	29,6	19,4	7,0	20	6,94
039-12-12G	12	G1/2	49,5	34,9	22,4	8,5	24	8,43

Mehrfachverteiler (Typ QSQ-B) - drehbar

Schlauch							
Bestell-Nr.	Ø	Gewinde	B	C	A	H	Euro
039-4-184	4	R1/8	41,5	14,5	8	11	4,32
039-4-186	6	R1/8	45,0	15,5	8	13	5,60
039-4-144	4	R1/4	44,5	14,5	11	14	4,41
039-4-146	6	R1/4	47,5	15,5	11	14	6,35

Mehrfachverteiler (Typ QSQ-G-B) - drehbar

Schlauch							
Bestell-Nr.	Ø	Gewinde	B	C	A	H	Euro
039-4-184G	4	G1/8	38,3	14,5	5	13	4,65
039-4-186G	6	G1/8	41,3	15,5	5	13	6,02
039-4-144G	4	G1/4	39,0	14,5	6	16	4,74
039-4-146G	6	G1/4	42,5	15,5	6	16	6,85

Y-Steckverschraubungen (Typ QSY-B) - drehbar

Schlauch							
Bestell-Nr.	Ø	Gewinde	B	A	H	DN	Euro
040-18-4	4	R1/8	40,6	8	10	3,5	2,60
040-18-6	6	R1/8	43,7	8	11	5,0	2,80
040-18-8	8	R1/8	52,6	8	13	6,0	3,16
040-18-10	10	R1/8	53,0	8	17	6,0	3,90
040-14-4	4	R1/4	43,6	11	14	3,5	2,71
040-14-6	6	R1/4	46,7	11	14	5,0	2,95
040-14-8	8	R1/4	55,1	11	14	7,0	3,25
040-14-10	10	R1/4	56,0	11	17	8,0	3,99
040-14-12	12	R1/4	65,9	11	19	8,0	4,65
040-38-6	6	R3/8	47,7	12	17	5,0	3,39
040-38-8	8	R3/8	56,1	12	17	7,0	3,39
040-38-10	10	R3/8	58,0	12	17	9,0	4,23
040-38-12	12	R3/8	67,9	12	19	11,0	4,77
040-12-8	8	R1/2	60,1	15	21	7,0	4,17
040-12-10	10	R1/2	61,0	15	21	9,0	4,65
040-12-12	12	R1/2	70,9	15	21	11,0	5,01

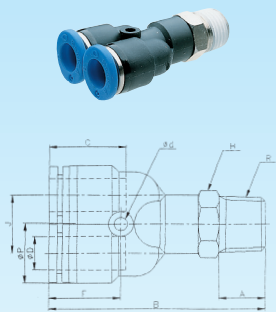
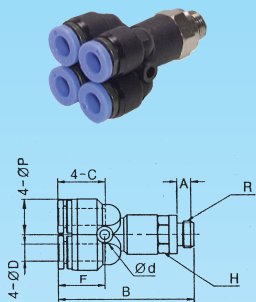
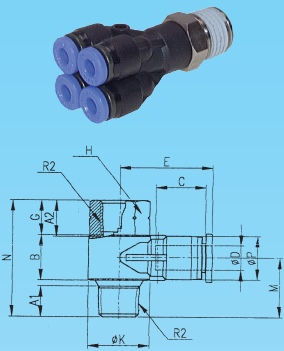
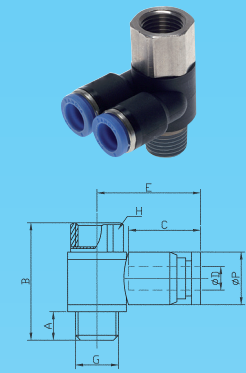

Y-Steckverschraubungen (Typ QSY-G-B) - drehbar

Bestell-Nr.	Schlauch		B	A	H	DN	Euro
	Ø	Gewinde					
040-5-4	4	M5	37,4	4,0	9	2,0	2,89
040-5-6	6	M5	40,5	4,0	11	2,0	3,16
040-18-4G	4	G1/8	37,4	5,0	13	3,5	2,59
040-18-6G	6	G1/8	40,1	5,0	13	5,0	2,80
040-18-8G	8	G1/8	48,9	5,0	13	6,0	3,16
040-18-10G	10	G1/8	53,8	5,0	17	6,0	3,90
040-14-4G	4	G1/4	38,1	6,0	16	3,5	2,71
040-14-6G	6	G1/4	37,7	6,0	16	5,0	2,95
040-14-8G	8	G1/4	50,1	6,0	16	7,0	3,28
040-14-10G	10	G1/4	54,5	6,0	17	8,0	3,99
040-14-12G	12	G1/4	64,4	6,0	19	8,0	4,65
040-38-6G	6	G3/8	38,7	7,0	20	5,0	3,40
040-38-8G	8	G3/8	51,1	7,0	20	7,0	3,40
040-38-10G	10	G3/8	53,0	7,0	20	9,0	4,23
040-38-12G	12	G3/8	62,9	7,0	20	10,0	4,77
040-12-8G	8	G1/2	53,1	8,5	24	7,0	4,17
040-12-10G	10	G1/2	54,5	8,5	24	9,0	4,65
040-12-12G	12	G1/2	64,4	8,5	24	10,0	5,01

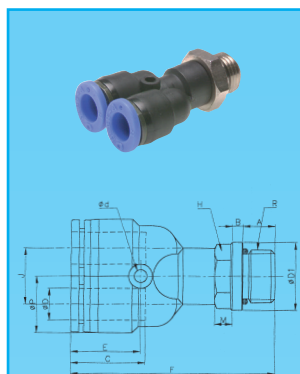

T-Mehrfachverteiler (QST3-B) - drehbar - mit 4 Abgängen

Bestell-Nr.	Schlauch		Gewinde	B	A	H	Euro
	Ø D1	Ø D2					
041-18-6-4	6	4	R1/8	63,8	8	11	4,41
041-14-8-4	8	4	R1/4	70,3	11	14	5,27
041-14-8-6	8	6	R1/4	76,9	11	14	5,72
041-38-8-6	8	6	R3/8	77,9	12	17	6,41
041-38-10-8	10	8	R3/8	88,4	12	17	6,73

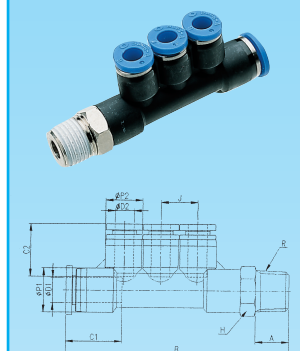

Mehrfachverteiler (QSLV2-B) - drehbar - mit 2 Abgängen

Bestell-Nr.	Schlauch		B	E	A	SW	Euro
	Ø	Gewinde					
042-18-4	4	R1/8	44,2	22,3	8	14	6,88
042-18-6	6	R1/8	44,2	26,5	8	14	7,21
042-18-8	8	R1/8	46,2	29,1	8	17	7,96
042-14-4	4	R1/4	47,2	22,3	11	14	7,06
042-14-6	6	R1/4	47,2	26,5	11	14	7,45
042-14-8	8	R1/4	49,2	29,1	11	17	8,17
042-14-10	10	R1/4	58,6	34,3	11	21	8,97
042-38-4	4	R3/8	48,2	22,3	12	14	7,72
042-38-6	6	R3/8	48,2	26,5	12	17	8,17
042-38-8	8	R3/8	50,2	29,1	12	17	8,49
042-38-10	10	R3/8	59,6	34,3	12	21	9,03
042-38-12	12	R3/8	69,8	38,3	12	27	9,51
042-12-8	8	R1/2	53,2	29,1	15	21	8,82
042-12-10	10	R1/2	62,6	34,3	15	21	9,36
042-12-12	12	R1/2	72,8	38,3	15	27	10,25

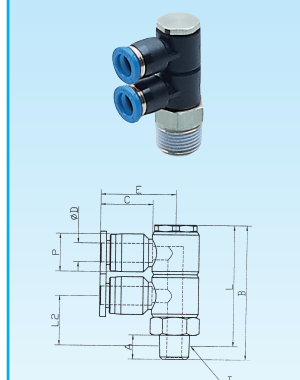

Mehrfachverteiler (QSLV3-B) - drehbar - mit 3 Abgängen

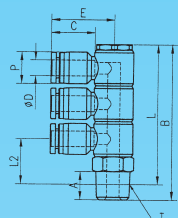

Schlauch							Euro
Bestell-Nr.	Ø	Gewinde	B	E	A	SW	
043-18-4	4	R1/8	58,2	22,3	8	14	8,31
043-18-6	6	R1/8	58,2	26,5	8	14	8,43
043-18-8	8	R1/8	61,3	29,1	8	17	9,63
043-14-4	4	R1/4	61,2	22,3	11	14	8,49
043-14-6	6	R1/4	61,2	26,5	11	14	8,58
043-14-8	8	R1/4	64,3	29,1	11	17	9,74
043-14-10	10	R1/4	76,2	34,3	11	21	11,18
043-38-4	4	R3/8	62,2	22,3	12	17	9,12
043-38-6	6	R3/8	62,2	26,5	12	17	9,30
043-38-8	8	R3/8	65,3	29,1	12	17	9,89
043-38-10	10	R3/8	77,2	34,3	12	21	11,41
043-38-12	12	R3/8	91,3	38,3	12	27	12,46
043-12-8	8	R1/2	68,2	29,1	15	21	10,70
043-12-10	10	R1/2	80,2	34,3	15	21	11,98
043-12-12	12	R1/2	94,0	38,3	15	27	13,56

Mehrfachverteiler (QSLV4-B) - drehbar - mit 4 Abgängen

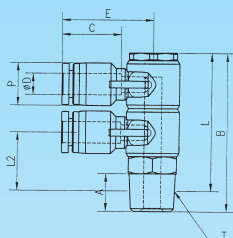

Schlauch							Euro
Bestell-Nr.	Ø	Gewinde	B	E	A	SW	
044-18-4	4	R1/8	44,2	22,3	8	14	8,40
044-18-6	6	R1/8	44,2	26,5	8	14	8,58
044-18-8	8	R1/8	46,2	29,1	8	17	9,77
044-14-4	4	R1/4	47,2	22,3	11	14	8,55
044-14-6	6	R1/4	47,2	26,5	11	14	8,82
044-14-8	8	R1/4	49,2	29,1	11	17	10,07
044-14-10	10	R1/4	58,6	34,3	11	21	11,09
044-38-4	4	R3/8	48,2	22,3	12	14	9,27
044-38-6	6	R3/8	48,2	26,5	12	17	9,51
044-38-8	8	R3/8	50,2	29,1	12	17	10,07
044-38-10	10	R3/8	59,6	34,3	12	21	11,41
044-38-12	12	R3/8	69,8	38,3	12	27	12,07
044-12-8	8	R1/2	53,2	29,1	15	21	10,88
044-12-10	10	R1/2	62,6	34,3	15	21	11,65
044-12-12	12	R1/2	72,8	38,3	15	27	12,69

Mehrfachverteiler (QSLV6-B) - drehbar - mit 6 Abgängen

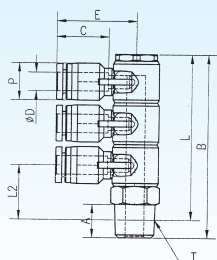

Schlauch							Euro
Bestell-Nr.	Ø	Gewinde	B	E	A	SW	
045-18-4	4	R1/8	58,2	22,3	8	14	9,03
045-18-6	6	R1/8	58,2	26,5	8	14	9,36
045-18-8	8	R1/8	61,3	29,1	8	17	10,64
045-14-4	4	R1/4	61,2	22,3	11	14	9,27
045-14-6	6	R1/4	61,2	26,5	11	14	9,63
045-14-8	8	R1/4	64,3	29,1	11	17	10,88
045-14-10	10	R1/4	76,2	34,3	11	21	13,89
045-38-4	4	R3/8	62,2	22,3	12	17	9,89
045-38-6	6	R3/8	62,2	26,5	12	17	10,22
045-38-8	8	R3/8	65,3	29,1	12	17	10,76
045-38-10	10	R3/8	77,2	34,3	12	21	13,95
045-38-12	12	R3/8	91,3	38,3	12	27	15,62
045-12-8	8	R1/2	68,2	29,1	15	21	13,02
045-12-10	10	R1/2	80,2	34,3	15	21	14,51
045-12-12	12	R1/2	94,0	38,3	15	27	17,08

Schott-Steckverbindungen (Typ QSS-B)

Bestell-Nr.	Schlauch					Euro
	Ø	B	M	H	E max.	
046-4	4	30,0	M12X1,0	14	8,6	3,40
046-6	6	31,9	M14X1,0	17	9,4	3,67
046-8	8	37,0	M16X1,0	19	10,6	4,02
046-10	10	40,1	M20X1,0	24	12,9	5,07
046-12	12	45,8	M22X1,0	26	15,4	6,23

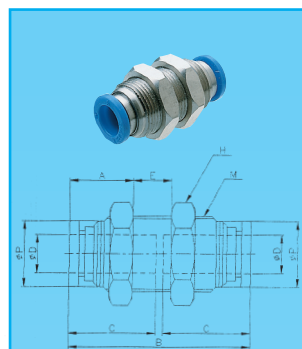

Schott-Steckverbindungen (Typ QSSK-B)

Bestell-Nr.	Schlauch					Euro
	Ø	B	M	H	E max.	
046SK-4	4	30,0	M12X1,5	14	7,1	2,29
046SK-6	6	31,9	M14X1,5	17	8,6	2,44
046SK-8	8	36,6	M16X1,5	19	8,8	2,59
046SK-10	10	40,0	M20X2,0	24	10,2	3,31
046SK-12	12	46,0	M24X2,0	27	11,9	4,41

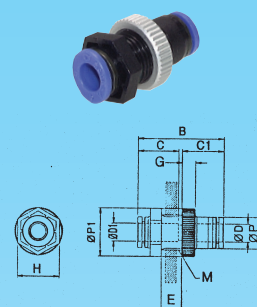

Winkel-Schott-Steckverbindungen (Typ QSLB-B)

Bestell-Nr.	Schlauch Ø	Schott-gewinde	Schott max.	Euro	
				Ø P1	Ø P2
046WS-4	4	M12x1,5	6	4,53	
046WS-6	6	M14X1,5	8	4,92	
046WS-8	8	M16X1,5	8	5,24	
046WS-10	10	M20X2,0	9	6,59	
046WS-12	12	M24X2,0	11	8,79	

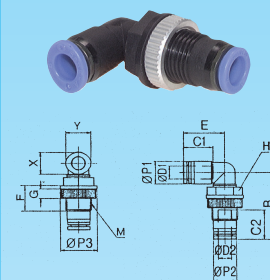

Steckverbindungen (Typ QSG-B) - für 2 Schlauchanschlüsse

Bestell-Nr.	Schlauch		B	Euro
	Ø D1	Ø D2		
047-4-4	4	4	30,2	1,37
047-6-4	6	4	31,5	1,85
047-6-6	6	6	32,0	1,40
047-8-4	8	4	33,3	2,32
047-8-6	8	6	34,3	2,00
047-8-8	8	8	40,2	1,55
047-10-6	10	6	35,9	2,95
047-10-8	10	8	38,2	2,56
047-10-10	10	10	40,0	2,03
047-12-8	12	8	41,2	3,19
047-12-10	12	10	42,8	2,74
047-12-12	12	12	54,8	2,41
047-14-14	14	14	50,8	3,16
047-15-15	15	15	Sonder-Ausführung komplett Kunststoff schwarz	5,54
047-16-12	16	12	48,9	4,20
047-16-16	16	16	52,0	3,78
047-18-18	18	18	Sonder-Ausführung komplett Kunststoff schwarz	8,82
047-22-22	22	22	Sonder-Ausführung komplett Kunststoff schwarz	10,19
047-28-28	28	28	Sonder-Ausführung komplett Kunststoff schwarz	21,87

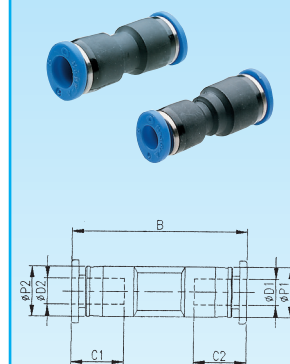

Steckverbindungen reduzierend (Typ QSG-B) - mit Stecknippel

Bestell-Nr.	Schlauch		B	C1	C2	Euro
	Ø D1	Ø D2				
048-4-6	4	6	-	-	-	2,18
048-6-4	6	4	36,1	15,5	14,5	2,15
048-8-4	8	4	36,9	17,8	14,5	2,35
048-8-6	8	6	39,5	17,8	15,5	2,38
048-10-6	10	6	40,3	19,4	15,5	2,50
048-10-8	10	8	45,6	19,4	17,8	3,07
048-12-6	12	6	45,0	22,4	15,5	3,58
048-12-8	12	8	46,6	22,4	17,8	3,58
048-12-10	12	10	46,6	22,4	19,4	3,58
048-14-12	14	12	-	-	-	3,13
048-15-12	15	12	Sonder-Ausführung komplett Kunststoff schwarz			6,76
048-18-15	18	15	Sonder-Ausführung komplett Kunststoff schwarz			7,15
048-22-15	22	15	Sonder-Ausführung komplett Kunststoff schwarz			7,39
048-22-18	22	18	Sonder-Ausführung komplett Kunststoff schwarz			7,42
048-28-15	28	15	Sonder-Ausführung komplett Kunststoff schwarz			15,32
048-28-22	28	22	Sonder-Ausführung komplett Kunststoff schwarz			19,64

Stecknippel (Typ QSGT-B) - mit Schlauchtülle für PVC-Schlauch

Bestell-Nr.	für Schlauch		B	C	Euro
	Ø D1	innen Ø			
048SN-4-4	4	4	36,0	16,0	1,28
048SN-4-5	4	5	36,0	16,0	1,52
048SN-6-5	6	5	41,0	17,0	1,46
048SN-6-6	6	6	41,0	17,0	1,85
048SN-8-6	8	6	43,0	18,5	1,64
048SN-8-8	8	8	48,2	18,5	1,64
048SN-10-8	10	8	50,2	21,0	1,97
048SN-12-8	12	8	54,2	22,5	2,35
048SN-12-10	12	10	54,7	22,5	2,09
048SN-12-13	12	13	55,0	22,5	2,15
048SN-14-14	14	14	59,5	24,5	2,35

Steckhülsen (Typ QSH-B) - auch reduzierend

Bestell-Nr.	Ø D1	Ø D2	B	Euro
049-4-4	4	4	35,0	1,13
049-6-4	6	4	36,0	1,40
049-6-6	6	6	37,0	1,25
049-8-4	8	4	-	1,64
049-8-6	8	6	39,0	1,55
049-8-8	8	8	39,5	1,37
049-10-6	10	6	-	1,85
049-10-8	10	8	43,0	1,76
049-10-10	10	10	46,0	1,58
049-12-8	12	8	-	2,09
049-12-10	12	10	48,0	1,97
049-12-12	12	12	50,0	2,03
049-14-14	14	14	-	2,09
049-16-12	16	12	54,0	2,35
049-16-16	16	16	-	2,12

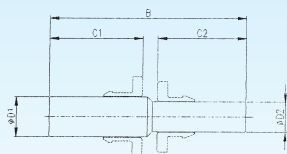
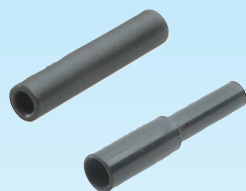
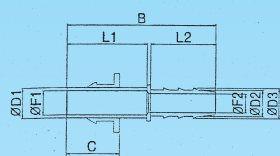
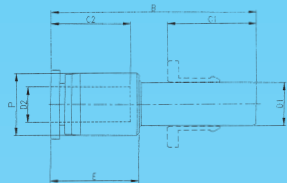

L-Steckverbindungen reduzierend (Typ QSLH-B) - mit Stecknippel

Bestell-Nr.	Schlauch		B	E	Ø P	Euro
	Ø D1	Ø D2				
050-4-4	4	4	23,5	17,1	9,0	1,70
050-6-4	6	4	28,5	17,1	9,0	2,18
050-6-6	6	6	29,6	18,0	11,2	1,94
050-8-6	8	6	30,6	18,0	11,2	2,41
050-8-8	8	8	32,8	23,6	13,6	2,18
050-10-8	10	8	33,8	23,6	13,6	3,19
050-10-10	10	10	36,2	25,0	16,3	2,50
050-12-10	12	10	38,2	25,0	16,3	3,70
050-12-12	12	12	39,9	32,2	19,7	2,92
050-14-14	14	14	42,8	31,9	23,5	3,28
050-15-15	15	15	Sonder-Ausführung komplett Kunststoff schwarz			8,28
050-16-16	16	16	44,8	34,0	25,6	4,65
050-18-18	18	18	Sonder-Ausführung komplett Kunststoff schwarz			9,36

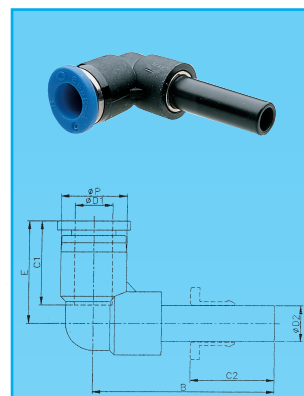

Winkel-Steckverbindungen (Typ QSL-B)

Bestell-Nr.	Schlauch			Euro
	Ø	F	Ø P	
051-4	4	6,0	9,0	1,31
051-6	6	6,7	11,2	1,40
051-8	8	8,5	13,6	1,52
051-10	10	10,0	16,3	1,97
051-12	12	12,0	19,7	2,21
051-14	14	13,5	23,5	3,40
051-15	15	Sonder-Ausführung komplett Kunststoff schwarz		7,51
051-16	16	15,0	25,6	3,78
051-18	18	Sonder-Ausführung komplett Kunststoff schwarz		9,83
051-22	22	Sonder-Ausführung komplett Kunststoff schwarz		11,12
051-28	28	Sonder-Ausführung komplett Kunststoff schwarz		26,05

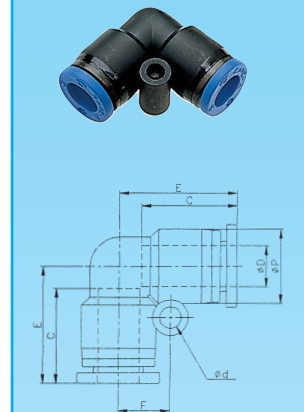

T-Steckverbindungen (Typ QST-B) - auch reduzierend

Bestell-Nr.	Schlauch		B	E	Euro
	Ø D2 x links+rechts	Ø D1 x nach unten			
052-4	4	4	34,2	17,1	1,58
052-6-4	6	4	37,9	19,0	1,73
052-6	6	6	38,0	19,0	1,73
052-8-4	8	4	-	-	2,86
052-8-6	8	6	47,2	23,6	1,85
052-8	8	8	47,2	23,6	1,85
052-10-6	10	6	-	-	3,25
052-10-8	10	8	50,0	25,0	2,06
052-10	10	10	50,0	25,0	2,06
052-12-8	12	8	-	-	4,59
052-12-10	12	10	64,4	32,2	2,89
052-12	12	12	64,4	32,2	2,89
052-14	14	14	63,8	31,9	5,24
052-15	15	15	Sonder-Ausführung komplett Kunststoff schwarz		10,04
052-16	16	16	68,0	34,0	5,04
052-18-15	18	15	Sonder-Ausführung komplett Kunststoff schwarz		15,38
052-18	18	18	Sonder-Ausführung komplett Kunststoff schwarz		13,74
052-22-15	22	15	Sonder-Ausführung komplett Kunststoff schwarz		15,38
052-22	22	22	Sonder-Ausführung komplett Kunststoff schwarz		15,38
052-28	28	28	Sonder-Ausführung komplett Kunststoff schwarz		30,81

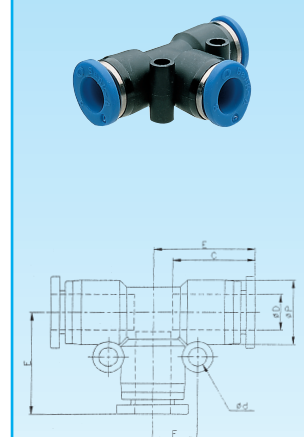

X-Steckverbindungen (Typ QSX-B)

Bestell-Nr.	Schlauch			Euro
	Ø	E	Ø P	
053-4	4	17,1	9,0	3,13
053-6	6	19,0	11,2	3,34
053-8	8	23,6	13,6	3,58
053-10	10	25,0	16,3	4,02
053-12	12	32,2	19,7	5,07

X-Steckverbindungen (Typ QSX3-B) - mit 2 reduzierten Abgängen

Bestell-Nr.	Schlauch	Schlauch	B1	B2	Euro
	Ø D2	Ø D1			
053-2-8-6	6	8	47,2	39,9	4,02
053-2-10-8	8	10	50,0	48,2	4,62
053-2-12-10	10	12	64,4	51,0	5,75

X-Steckverbindungen (Typ QSX2-B) - mit 3 reduzierten Abgängen

Bestell-Nr.	Schlauch	Schlauch	B1	B2	Euro
	Ø D2	Ø D1			
053-3-8-6	6	8	43,6	39,9	4,02
053-3-10-8	8	10	49,1	48,2	4,62
053-3-12-10	10	12	57,7	51,0	5,75

Y-Steckverbindungen (Typ QSY-B) - für 3 Schlauchanschlüsse

Bestell-Nr.	Schlauch				Euro
	Ø	B	Ø P	DN	
054-4	4	31,2	9,0	3,2	1,67
054-6	6	34,7	11,2	5,0	1,85
054-8	8	44,2	13,6	7,0	1,91
054-10	10	46,0	16,3	9,0	2,15
054-12	12	56,8	19,7	10,0	2,89
054-14	14	59,3	23,5	12,0	4,89
054-16	16	62,0	25,6	14,0	5,22

Y-Steckverbindungen (Typ QSY-B) - mit reduzierten Abgängen

Bestell-Nr.	Schlauch	Schlauch	B	Ø P1	Euro
	1 Zugang	2 Abgänge			
055-6-4	6	4	32,5	9,0	2,80
055-8-4	8	4	37,7	11,2	3,10
055-8-6	8	6	38,5	11,2	2,89
055-10-6	10	6	42,6	13,6	3,52
055-10-8	10	8	43,2	13,6	3,34
055-12-8	12	8	50,5	16,3	4,80
055-12-10	12	10	50,9	16,3	4,53

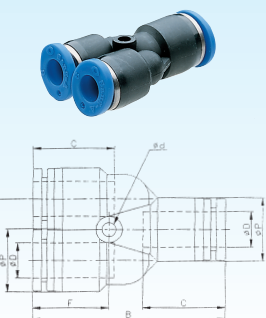
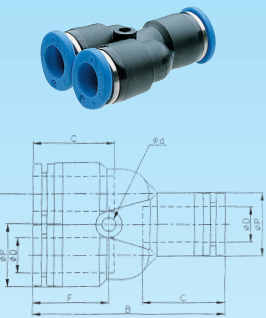
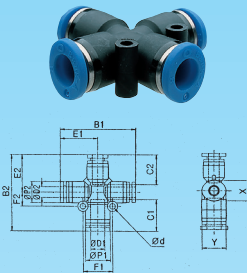
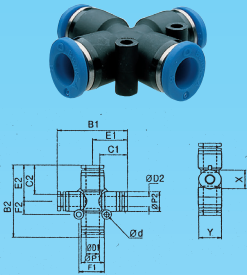
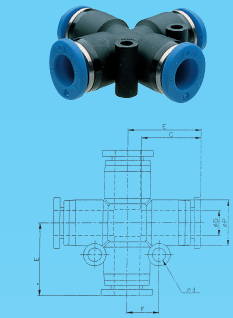

T-Mehrfachverteiler (Typ QST3-B) - mit 3 reduzierten Abgängen

Bestell-Nr.	Schlauch		B	F2	Euro
	Ø D1	Ø D2			
056-6-4	6	4	54,7	30,6	3,61
056-8-4	8	4	59,4	31,6	4,14
056-8-6	8	6	66,0	38,8	5,57
056-10-6	10	6	68,8	38,8	5,69
056-10-8	10	8	76,4	47,4	5,93

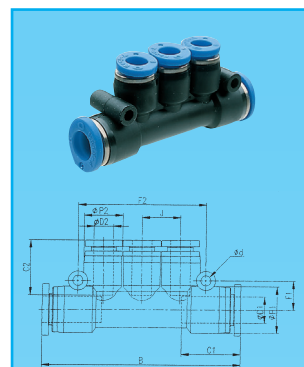

Y-Steckverbindungen (Typ QSY-H-B) - reduzierend mit Stecknippel

Bestell-Nr.	Schlauch		B	Ø P	Euro
	Ø D1	Ø D2			
057-6-4	4	6	42,8	9,0	3,28
057-8-6	6	8	45,5	11,2	3,78
057-10-8	8	10	53,1	13,6	4,32
057-12-10	10	12	58,0	16,3	5,13

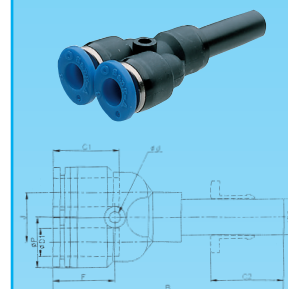

Y-Steckverbindungen (Typ QSY-H-B) - mit Stecknippel

Bestell-Nr.	Schlauch		B	Ø P	Euro
	Ø D1	Ø D2			
058-4-4	4	4	37,8	9,0	3,13
058-6-6	6	6	45,0	11,2	3,22
058-8-8	8	8	53,1	13,6	3,73
058-10-10	10	10	56,0	16,3	4,20
058-12-12	12	12	63,4	19,7	5,01

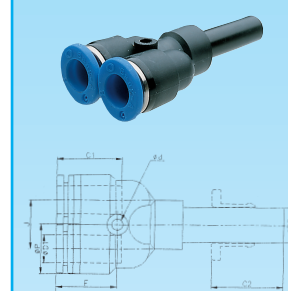

T-Mehrfachverteiler (Typ QST3-B) - mit 3 reduzierten Abgängen

Bestell-Nr.	Schlauch			B	Ø P1	Ø P2	Euro
	Ø D1	Ø D2	Ø D3				
059-6-4	6	4	6	64,2	11,2	9,0	4,47
059-8-4	8	4	8	68,5	13,6	9,0	4,56
059-8-6	8	6	8	75,0	13,6	11,2	4,65
059-10-8	10	8	10	86,2	16,3	13,6	5,39

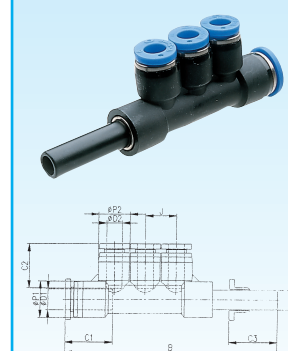

Stopfen (Typ QSC-H-B) - zum Verschließen von Steckanschlüssen

Bestell-Nr.	Schlauch			Euro
	Ø	B	C	
060-4	4	28	15	0,66
060-5	5	-	-	1,10
060-6	6	32	17	0,66
060-8	8	39	18	0,72
060-10	10	42	20	0,83
060-12	12	44	22	0,95
060-14	14	-	-	1,19
060-15	15	-	-	2,26
060-16	16	-	-	1,19
060-18	18	-	-	2,95
060-22	22	-	-	2,95
060-28	28	-	-	3,99

Schalldämpfer (Typ QSSD-B) - mit Stecknippel

Bestell-Nr.	Schlauch Ø	Höhe	Toleranz	Betriebs- druck	Euro
			Höhe		
061SD-4	4	32,0	+ - 3mm	max. 10 bar	4,11
061SD-6	6	45,0	+ - 3mm	max. 10 bar	4,35
061SD-8	8	43,5	+ - 3mm	max. 10 bar	4,35
061SD-10	10	57,5	+ - 3mm	max. 10 bar	6,11
061SD-12	12	82,0	+ - 3mm	max. 10 bar	7,48

Steckkappen (Typ QSC-B) - zum Verschließen von Schlauch-Leitungen

Bestell-Nr.	Schlauch			Euro
	Ø	B	Ø P	
061-4	4	15,6	9,0	0,89
061-6	6	17,0	11,2	0,95
061-8	8	19,8	13,6	1,10
061-10	10	21,0	16,3	1,22
061-12	12	25,4	19,7	1,37

Steckanschluss-Einschraubtülle (Typ QSG-H-B) - zur Kombination

Bestell-Nr.	Schlauch						Euro
	Ø	Gewinde	B	L	A	H	
061SE-18-4	4	R1/8	34,4	18	8	10	1,88
061SE-18-6	6	R1/8	39,4	23	8	10	1,88
061SE-18-8	8	R1/8	41,5	25	8	10	2,41
061SE-14-4	4	R1/4	37,4	18	11	14	2,50
061SE-14-6	6	R1/4	42,2	23	11	14	2,50
061SE-14-8	8	R1/4	44,0	25	11	14	2,44
061SE-14-10	10	R1/4	49,1	27	11	17	3,34
061SE-14-12	12	R1/4	51,1	29	11	17	3,99
061SE-38-6	6	R3/8	43,4	23	12	17	3,01
061SE-38-8	8	R3/8	45,0	25	12	17	3,01
061SE-38-10	10	R3/8	48,6	27	12	17	3,10
061SE-38-12	12	R3/8	50,6	29	12	17	3,99
061SE-38-16	16	R3/8	57,5	31	12	20	6,11
061SE-12-10	10	R1/2	51,6	27	15	21	4,29
061SE-12-12	12	R1/2	53,6	29	15	21	4,32
061SE-12-16	16	R1/2	60,0	31	15	21	6,82

Steckanschluss-Einschraubtülle (Typ QSG-H-G-B) - zur Kombination

Bestell-Nr.	Schlauch						Euro
	Ø	Gewinde	B	L	A	H	
061SE-5-4	4	M5	31,2	18	4	9	1,97
061SE-5-6	6	M5	36,2	23	4	9	1,97
061SE-18-4G	4	G1/8	31,2	18	5	13	1,88
061SE-18-6G	6	G1/8	36,2	23	5	13	1,88
061SE-18-8G	8	G1/8	40,8	25	5	13	2,41
061SE-14-4G	4	G1/4	31,9	18	6	16	2,50
061SE-14-6G	6	G1/4	36,9	23	6	16	2,50
061SE-14-8G	8	G1/4	39,0	25	6	16	2,44
061SE-14-10G	10	G1/4	45,1	27	6	16	3,34
061SE-14-12G	12	G1/4	47,1	29	6	16	3,99
061SE-38-6G	6	G3/8	38,4	23	7	20	3,01
061SE-38-8G	8	G3/8	40,0	25	7	20	3,01
061SE-38-10G	10	G3/8	43,6	27	7	20	3,10
061SE-38-12G	12	G3/8	45,6	29	7	20	3,99
061SE-38-16G	16	G3/8	53,0	31	7	20	6,11
061SE-12-10G	10	G1/2	45,1	27	9	24	4,29
061SE-12-12G	12	G1/2	47,1	29	9	24	4,32
061SE-12-16G	16	G1/2	48,5	31	9	24	6,82

Steckanschluss-Einschraubtülle (Typ QSG-H-G-B) zur Kombination - NPT/UNF-Gewinde

Bestell-Nr.	Schlauch		Euro
	Ø	Gewinde	
061SE-10-4U	4	10-32 UNF	2,26
061SE-10-6U	6	10-32 UNF	2,26
061SE-18-4N	4	NPT1/8	2,15
061SE-18-6N	6	NPT1/8	2,15
061SE-18-8N	8	NPT1/8	2,77
061SE-14-4N	4	NPT1/4	2,92
061SE-14-6N	6	NPT1/4	2,92
061SE-14-8N	8	NPT1/4	2,83
061SE-14-10N	10	NPT1/4	3,87
061SE-38-8N	8	NPT3/8	3,49
061SE-38-10N	10	NPT3/8	3,58
061SE-38-12N	12	NPT3/8	4,59
061SE-12-12N	12	NPT1/2	4,98

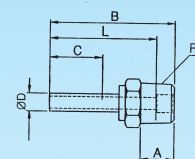
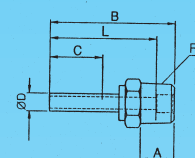

Steckverschraubungen - zöllig



Werkstoffe:	Körper: Messing vernickelt / PBT, Dichtung: NBR, Haltekrallen: Edelstahl, Patrone: ZNDC
Temperaturbereich:	0 °C bis max. +60 °C
Betriebsdruck:	-0,95 bis 10 bar
Medien:	Druckluft, neutrale Gase sowie Wasser (Wasser bis max. 60 °C darf nur nach Freigabe der Rahmendaten durch uns verwendet werden)

Umrechnungstabellen

Gewinde	Durchmesser
UNF10-32	4,83 zylindrisch
NPT 1/16"	8,1
NPT 1/8"	10,3
NPT 1/4"	13,7
NPT 3/8"	17,2
NPR 1/2"	21,3

Schlauch Inch	Außen Ø mm
1/8"	3,17
5/32"	3,97
3/16"	4,76
1/4"	6,35
5/16"	7,94
3/8"	9,52
1/2"	12,7



Steckverschraubung - mit Außensechskant

NEU!

Bestell-Nr.	Schlauch Ø D	Gewinde R	Euro
030-U10-1/8	1/8"	10-32 UNF	1,48
030-U10-5/32	5/32"	10-32 UNF	1,50
030-U10-3/16	3/16"	10-32 UNF	1,59
030-U10-1/4	1/4"	10-32 UNF	1,59
030-N116-1/8	1/8"	1/16 NPT	1,48
030-N116-5/32	5/32"	1/16 NPT	1,48
030-N18-5/32	5/32"	1/8 NPT	1,21
030-N18-3/16	3/16"	1/8 NPT	1,18
030-N18-1/4	1/4"	1/8 NPT	1,18
030-N18-5/16	5/16"	1/8 NPT	1,27
030-N18-3/8	3/8"	1/8 NPT	1,86
030-N14-5/32	5/32"	1/4 NPT	1,33
030-N14-3/16	3/16"	1/4 NPT	1,27
030-N14-1/4	1/4"	1/4 NPT	1,27
030-N14-5/16	5/16"	1/4 NPT	1,30
030-N14-3/8	3/8"	1/4 NPT	1,68
030-N14-1/2	1/2"	1/4 NPT	2,33
030-N38-1/4	1/4"	3/8 NPT	1,68
030-N38-5/16	5/16"	3/8 NPT	1,59
030-N38-3/8	3/8"	3/8 NPT	1,83
030-N38-1/2	1/2"	3/8 NPT	2,36
030-N12-3/8	3/8"	1/2 NPT	2,27
030-N12-1/2	1/2"	1/2 NPT	2,71

L-Steckverschraubung - mit Außensechskant - drehbar

NEU!

Bestell-Nr.	Schlauch Ø D	Gewinde R	Euro
033-U10-1/8	1/8"	10-32 UNF	2,01
033-U10-5/32	5/32"	10-32 UNF	1,68
033-U10-3/16	3/16"	10-32 UNF	2,01
033-U10-1/4	1/4"	10-32 UNF	2,01
033-N116-1/8	1/8"	1/16 NPT	2,01
033-N116-5/32	5/32"	1/16 NPT	2,01
033-N18-1/8	1/8"	1/8 NPT	1,86
033-N18-5/32	5/32"	1/8 NPT	1,48
033-N18-3/16	3/16"	1/8 NPT	1,48
033-N18-1/4	1/4"	1/8 NPT	1,48
033-N18-5/16	5/16"	1/8 NPT	1,68
033-N18-3/8	3/8"	1/8 NPT	2,71
033-N14-5/32	5/32"	1/4 NPT	1,77
033-N14-3/16	3/16"	1/4 NPT	1,56
033-N14-1/4	1/4"	1/4 NPT	1,56
033-N14-5/16	5/16"	1/4 NPT	1,71
033-N14-3/8	3/8"	1/4 NPT	2,30
033-N14-1/2	1/2"	1/4 NPT	2,74
033-N38-1/4	1/4"	3/8 NPT	2,07
033-N38-5/16	5/16"	3/8 NPT	2,07
033-N38-3/8	3/8"	3/8 NPT	2,80
033-N38-1/2	1/2"	3/8 NPT	2,80
033-N12-3/8	3/8"	1/2 NPT	3,16
033-N12-1/2	1/2"	1/2 NPT	3,39



TE-Steckverschraubung - mit Außensechskant - drehbar

NEU!

Bestell-Nr.	Schlauch Ø D	Gewinde R	Euro
034-U10-1/8	1/8"	10-32 UNF	4,07
034-U10-5/32	5/32"	10-32 UNF	2,48
034-U10-3/16	3/16"	10-32 UNF	2,86
034-U10-1/4	1/4"	10-32 UNF	2,86
034-N116-1/8	1/8"	1/16 NPT	4,07
034-N116-5/32	5/32"	1/16 NPT	4,07
034-N18-1/8	1/8"	1/8 NPT	3,39
034-N18-5/32	5/32"	1/8 NPT	2,36
034-N18-3/16	3/16"	1/8 NPT	2,54
034-N18-1/4	1/4"	1/8 NPT	2,54
034-N18-5/16	5/16"	1/8 NPT	2,80
034-N18-3/8	3/8"	1/8 NPT	3,54
034-N14-5/32	5/32"	1/4 NPT	2,60
034-N14-3/16	3/16"	1/4 NPT	2,66
034-N14-1/4	1/4"	1/4 NPT	2,66
034-N14-5/16	5/16"	1/4 NPT	2,86
034-N14-3/8	3/8"	1/4 NPT	3,60
034-N14-1/2	1/2"	1/4 NPT	4,25
034-N38-1/4	1/4"	3/8 NPT	3,19
034-N38-5/16	5/16"	3/8 NPT	3,19
034-N38-3/8	3/8"	3/8 NPT	3,81
034-N38-1/2	1/2"	3/8 NPT	4,13
034-N12-3/8	3/8"	1/2 NPT	4,45
034-N12-1/2	1/2"	1/2 NPT	4,66



NEU!

Steckverbindungen - für 2 Schlauchanschlüsse

Bestell-Nr.	Schlauch		Euro
	Ø D1	Ø D2	
047-1/8	1/8"	1/8"	2,27
047-5/32	5/32"	5/32"	1,53
047-3/16-5/32	3/16"	5/32"	2,04
047-3/16	3/16"	3/16"	1,56
047-1/4-5/32	1/4"	5/32"	2,04
047-1/4-3/16	1/4"	3/16"	2,04
047-1/4	1/4"	1/4"	1,56
047-5/16-1/4	5/16"	1/4"	2,21
047-5/16	5/16"	5/16"	1,68
047-3/8-5/16	3/8"	5/16"	2,86
047-3/8	3/8"	3/8"	2,24
047-1/2-3/8	1/2"	3/8"	3,04
047-1/2	1/2"	1/2"	2,66

**NEU!**

Schott-Steckverbindungen

Bestell-Nr.	Schlauch Ø D1	Schott- gewinde	E max.	Bemerkung	Euro
046-5/32	5/32"	UNF 1/2	9	runder Lösering	3,75
046-3/16	3/16"	UNF 9/16	12	runder Lösering	4,04
046-1/4	1/4"	UNF 9/16	12	runder Lösering	4,04
046-5/16	5/16"	UNF 5/8	10	runder Lösering	4,40
046-3/8	3/8"	UNF 7/8	12	runder Lösering	5,58
046-1/2	1/2"	UNF 7/8	17	runder Lösering	6,84

**NEU!**

L-Steckverbindungen

Bestell-Nr.	Schlauch		Euro
	Ø D1	Ø D2	
051-1/8	1/8"	1/8"	2,27
051-5/32	5/32"	5/32"	1,48
051-3/16	3/16"	3/16"	1,56
051-1/4	1/4"	1/4"	1,56
051-5/16	5/16"	5/16"	1,65
051-3/8	3/8"	3/8"	2,15
051-1/2	1/2"	1/2"	2,45

**NEU!**

T-Steckverbindungen

Bestell-Nr.	Schlauch		Euro
	Ø D1	Ø D2	
052-1/8	1/8"	1/8"	2,60
052-5/32	5/32"	5/32"	1,71
052-3/16	3/16"	3/16"	1,92
052-1/4	1/4"	1/4"	1,92
052-5/16	5/16"	5/16"	2,01
052-3/8	3/8"	3/8"	2,27
052-1/2	1/2"	1/2"	3,19



Steckverbindungen - mit Stecknippel

NEU!

Bestell-Nr.	Schlauch D	Schlauch Ø D1	Euro
048-1/4-5/32	1/4"	5/32"	2,36
048-5/16-5/32	5/16"	5/32"	2,57
048-5/16-1/4	5/16"	1/4"	2,60
048-3/8-1/4	3/8"	1/4"	2,74
048-3/8-5/16	3/8"	5/16"	3,33
048-1/2-1/4	1/2"	1/4"	3,92
048-1/2-5/16	1/2"	5/16"	3,92
048-1/2-3/8	1/2"	3/8"	3,92



Steckverbindungen - mit Stecknippel - zöllig auf metrisch

NEU!

Bestell-Nr.	Schlauch D	Schlauch Ø D1	Euro
048-5/32-4	5/32"	4	2,36
048-3/16-4	3/16"	4	2,36
048-1/4-6	1/4"	6	3,10
048-5/16-8	5/16"	8	3,10
048-3/8-10	3/8"	10	3,81
048-1/2-12	1/2"	12	3,92

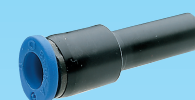

Stopfen - zum Verschließen von Steckanschlüssen

NEU!

Bestell-Nr.	Schlauch Ø D1	Euro
060-1/8	1/8"	0,68
060-5/32	5/32"	0,71
060-3/16	3/16"	0,71
060-1/4	1/4"	0,71
060-5/16	5/16"	0,77
060-3/8	3/8"	0,91
060-1/2	1/2"	1,06

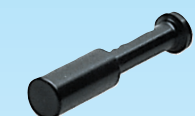

Drosselrückschlagventil

NEU!

Bestell-Nr.	Schlauch Ø D1	Euro
B088-5/32	5/32"	10,21
B088-3/16	3/16"	14,60
B088-1/4	1/4"	14,60
B088-5/16	5/16"	16,64
B088-3/8	3/8"	21,03
B088-1/2	1/2"	24,16



Mehrfachkupplungen

- Anwendung:** Für ein schnelles und verwechslungssicheres Kuppeln von mehreren Pneumatikschläuchen und Mehrfachanschlüssen
- Material:** Gehäuse und Steckerplatte: Aluminium; Dichtring: NBR; (Typ MFKR: Überwurfmutter- und Kontermutter: POM)
- Temperatur:** -20 °C bis +70 °C
- Druck:** -0,99 bis max. 15 bar, Variante MFKR max. bis 12 bar

Komplett - Stecker und Muffe

Bestell-Nr.	Schlauch		max.				Euro
	AD.	Anzahl	A	B	C	D	
Typ: beidseitig nicht absperrend, max. 15 bar							
MFK 412	4	12	93	113	103	88	290,73
MFK 420	4	20	120	140	130	115	388,62
MFK 610	6	10	93	113	103	88	300,06
MFK 614	6	14	120	140	130	115	353,76
MFK 88	8	8	93	113	103	88	325,27
MFK 810	8	10	120	140	130	115	410,61
Typ: beidseitig absperrend, max. 7 bar							
MFK66BA	6	6	73	94	83	66	244,61
MFK84BA	8	4	73	94	83	66	244,61

Stecker

Bestell-Nr.	Schlauch		max.				Euro
	AD.	Anzahl	A	B	C	D	
Typ: beidseitig nicht absperrend, max. 15 bar							
MFK 412ST	4	12	93	113	103	88	176,39
MFK 420ST	4	20	120	140	130	115	233,16
MFK 610ST	6	10	93	113	103	88	180,02
MFK 614ST	6	14	120	140	130	115	212,30
MFK 88ST	8	8	93	113	103	88	191,35
MFK 810ST	8	10	120	140	130	115	246,36
Typ: beidseitig absperrend, max. 7 bar							
MFK66ST-BA	6	6	73	94	83	66	146,76
MFK84ST-BA	8	4	73	94	83	66	146,76

Muffe

Bestell-Nr.	Schlauch		max.				Euro
	AD.	Anzahl	A	B	C	D	
Typ: beidseitig nicht absperrend, max. 15 bar							
MFK 412MU	4	12	93	113	103	88	114,34
MFK 420MU	4	20	120	140	130	115	155,47
MFK 610MU	6	10	93	113	103	88	120,06
MFK 614MU	6	14	120	140	130	115	141,49
MFK 88MU	8	8	93	113	103	88	133,95
MFK 810MU	8	10	120	140	130	115	164,26
Typ: beidseitig absperrend, max. 7 bar							
MFK66MU-BA	6	6	73	94	83	66	97,85
MFK84MU-BA	8	4	73	94	83	66	97,85

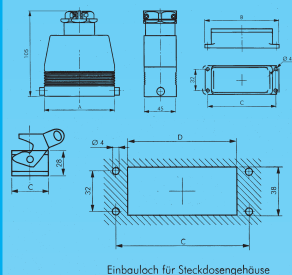

Komplett - Stecker und Muffe

Bestell-Nr.	Schlauch AD.	max. Anzahl	G Schottgewinde	Ersatz-O-Ringe	Euro
Typ: beidseitig nicht absperrend, max. 12 bar					
MFKR 412	4	12	M50x1,5	MFKR 4 OR	155,38
MFKR 610	6	10	M50x1,5	MFKR 6 OR	204,16
MFKR 88	8	8	M50x1,5	MFKR 8 OR	204,16

Stecker

Bestell-Nr.	Schlauch AD.	max. Anzahl	G Schottgewinde	Euro
Typ: beidseitig nicht absperrend, max. 12 bar				
MFKR 412ST	4	12	M50x1,5	62,70
MFKR 610ST	6	10	M50x1,5	81,68
MFKR 88ST	8	8	M50x1,5	81,68

Muffe

Bestell-Nr.	Schlauch AD.	max. Anzahl	G Schottgewinde	Euro
Typ: beidseitig nicht absperrend, max. 12 bar				
MFKR 412MU	4	12	M50x1,5	92,68
MFKR 610MU	6	10	M50x1,5	122,48
MFKR 88MU	8	8	M50x1,5	122,48

Einpresspatrone (Typ QSE-B) - Messing vernickelt

- Vorteile:**
- extrem kleine Abmaße
 - kein Gewindeloch notwendig
 - maschinelle Installation möglich
 - Patrone besteht nur aus einem Teil

- Arbeitsschritte:**
1. Herstellen des Stufenlochs durch Stufenbohrer oder Spritzgießen
 2. Einpressen der Patrone
 3. Seitliches Herausziehen der Montagesicherung

Lieferumfang: Einpresspatronen komplett mit Montagesicherung

Lösering Polyazetalharz

Bestell-Nr.	Schlauch Ø	Ø A	Ø B (+0,1)	Ø C (-0,05)	D (+0,1)	E (+0,1)	F	G	Euro
062-4NI	4	3	4,2	8,0	7,8	3,5	4,7	11	0,72
062-6NI	6	4	6,2	10,0	8,2	4,0	5,0	13	0,72
062-8NI	8	6	8,2	12,0	9,2	4,5	4,8	15	0,77
062-10NI	10	8	10,2	15,1	10,2	5,0	5,8	18	0,89
062-12NI	12	10	12,2	17,7	12,2	5,0	5,2	22	0,92

Datenblatt mit genauen Bohrlochmaßen auf Anfrage.

Stufenbohrer für Einpresspatronen HSS

Sie benötigen 2 Werkzeuge zur Herstellung des Stufenloches für die Einpresspatrone, Vorbohrer 3-stufig zum Vorbohren des Stufenloches, Fertigbohrer mit Führungsdorn zur maßhaltigen Endbearbeitung

Bestell-Nr. Vorbohrer	Euro	Bestell-Nr. Fertigbohrer	Euro	für Artikel
062-4-VB	260,07	062-4-FB	181,96	062-4NI
062-6-VB	316,71	062-6-FB	203,79	062-6NI
062-8-VB	368,75	062-8-FB	248,42	062-8NI
062-10-VB	405,63	062-10-FB	266,86	062-10NI
062-12-VB	543,42	062-12-FB	329,93	062-12NI

Stecker



Muffe



Vorbohrer



Fertigbohrer



Die MINI Reihe

Der Ministeckanschluss

Beschreibung: Unser kleinster Anschluss für besonders enge Einbauträume
 Schläuche: 3 - 6 mm
 Gewinde: M3 - 1/8"
 Temperatur: 0 °C bis +60 °C
 Druckbereich: -0,95 bis 10 bar
 Medien: Druckluft, neutrale Gase

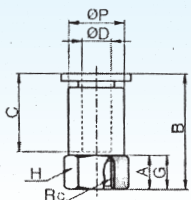
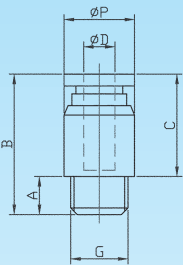
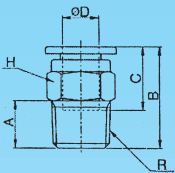
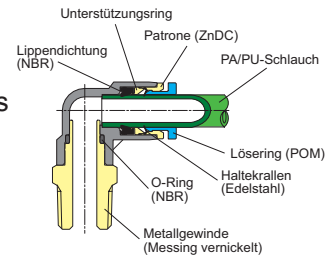

MINI Steckverschraubungen (Typ QSM-B) - mit Außensechskant

Schlauch						Euro
Bestell-Nr.	Ø	Gewinde	B	A	H	
065-3-3	3	M3	13,6	3,0	6	1,94
065-3-4	4	M3	15,5	3,0	8	2,38
065-5-3	3	M5	15,7	3,5	8	1,31
065-5-4	4	M5	15,7	3,5	8	1,55
065-5-6	6	M5	16,8	3,5	10	1,58
065-6-3	3	M6	16,5	4,5	8	1,76
065-6-4	4	M6	16,9	4,5	8	2,00
065-6-6	6	M6	17,8	4,5	10	2,03
065-18-4G	4	G1/8	-	-	-	1,22
065-18-4	4	R1/8	15,7	8,0	10	1,13
065-18-6G	6	G1/8	-	-	-	1,34
065-18-6	6	R1/8	17,9	8,0	10	1,22

MINI Steckverschraubungen (Typ QSMI-B) - mit Innensechskant

Schlauch						Euro
Bestell-Nr.	Ø	Gewinde	B	A	Ø P	
066-3-3	3	M3	15,9	3,0	6	2,06
066-3-4	4	M3	18,0	3,0	8	2,47
066-5-3	3	M5	17,5	3,5	8	1,46
066-5-4	4	M5	18,7	3,5	8	1,64
066-5-6	6	M5	17,3	3,5	10	1,67
066-6-3	3	M6	-	4,5	8	1,85
066-6-4	4	M6	19,7	4,5	8	2,18
066-6-6	6	M6	18,3	4,5	10	2,18
066-7-4	4	M7	-	-	-	1,73
066-7-6	6	M7	-	-	-	1,79
066-18-4G	4	G1/8	-	-	-	1,40
066-18-4	4	R1/8	15,8	8,0	10	1,28
066-18-6G	6	G1/8	-	-	-	1,37
066-18-6	6	R1/8	16,9	8,0	10	1,31

MINI Steckverschraubung (Typ QSMF-B) - mit Innengewinde

Schlauch							Euro
Bestell-Nr.	Ø	Gewinde	B	A	H	Ø P	
066IG-3-3	3	M3	14,9	3	8	8	1,76
066IG-3-4	4	M3	15,0	3	8	8	1,88
066IG-5-3	3	M5	16,9	5	8	8	1,76
066IG-5-4	4	M5	17,0	5	8	8	1,88

MINI Steckverschraubung 45° Winkel (Typ QSMW-B) - drehbar

Bestell-Nr.	Schlauch		Euro
	Ø	Gewinde	
067W-5-4	4	M5	8,58
067W-5-6	6	M5	8,88
067W-18-4	4	R1/8	7,24
067W-18-6	6	R1/8	7,27

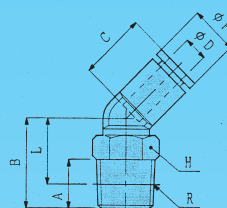

MINI L-Steckverschraubungen (Typ QSML-B) - drehbar

Bestell-Nr.	Schlauch		Euro
	Ø	Gewinde	
067-3-3	3	M3	2,80
067-3-4	4	M3	2,80
067-5-3	3	M5	1,85
067-5-4	4	M5	2,06
067-5-6	6	M5	2,06
067-6-3	3	M6	2,35
067-6-4	4	M6	2,38
067-6-6	6	M6	2,44
067-7-4	4	M7	2,12
067-7-6	6	M7	2,18
067-18-4G	4	G1/8	1,76
067-18-4	4	R1/8	1,67
067-18-6G	6	G1/8	1,88
067-18-6	6	R1/8	1,73

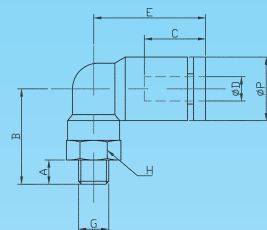

MINI L-Steckverschraubungen lang (Typ QSMLL-B) - drehbar

Bestell-Nr.	Schlauch		B	Ø P	E	A	H	Euro
	Ø	Gewinde						
067L-3-3	3	M3	19,4	6,0	11,2	3,0	6	4,44
067L-3-4	4	M3	23,0	8,0	15,6	3,0	8	4,53
067L-5-3	3	M5	25,5	6,0	11,2	3,5	8	3,75
067L-5-4	4	M5	25,5	8,0	15,6	3,5	8	2,92
067L-5-6	6	M5	25,5	10,5	16,9	3,5	8	3,16
067L-6-4	4	M6	26,0	8,0	15,6	4,5	8	3,25
067L-6-6	6	M6	26,0	10,5	16,9	4,5	8	3,58
067L-7-4	4	M7	-	-	-	-	-	2,95
067L-7-6	6	M7	-	-	-	-	-	3,25
067L-18-4G	4	G1/8	-	-	-	-	-	2,83
067L-18-4	4	R1/8	28,1	8,0	15,6	8,0	10	2,71
067L-18-6G	6	G1/8	-	-	-	-	-	3,22
067L-18-6	6	R1/8	29,4	10,5	16,9	8,0	10	3,07

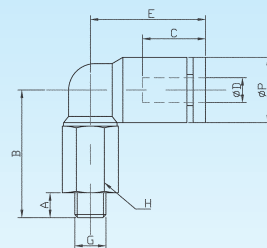

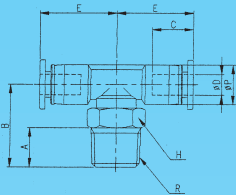

MINI TE-Steckverschraubungen (Typ QSMT-B) - drehbar

Schlauch			
Bestell-Nr.	Ø	Gewinde	Euro
068-3-3	3	M3	4,44
068-3-4	4	M3	4,44
068-5-3	3	M5	3,70
068-5-4	4	M5	3,43
068-5-6	6	M5	3,84
068-6-3	3	M6	4,11
068-6-4	4	M6	4,14
068-6-6	6	M6	4,20
068-18-4G	4	G1/8	3,25
068-18-4	4	R1/8	3,13
068-18-6G	6	G1/8	3,52
068-18-6	6	R1/8	3,34

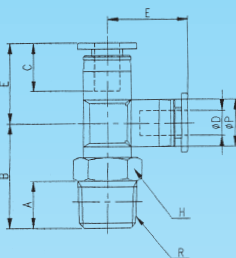

MINI LE-Steckverschraubungen (Typ QSMTL-B) - drehbar

Schlauch			
Bestell-Nr.	Ø	Gewinde	Euro
069-3-3	3	M3	4,44
069-3-4	4	M3	4,44
069-5-3	3	M5	3,70
069-5-4	4	M5	3,43
069-5-6	6	M5	3,84
069-6-3	3	M6	4,11
069-6-4	4	M6	3,93
069-6-6	6	M6	4,20
069-18-4G	4	G1/8	3,25
069-18-4	4	R1/8	3,13
069-18-6G	6	G1/8	3,52
069-18-6	6	R1/8	3,34

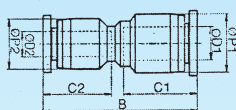

MINI Steckverbindungen (Typ QSM-B) - auch reduzierend

Schlauch		Schlauch		Euro
Bestell-Nr.	Ø D1	Ø D2	B	
065-SV-33	3	3	20,4	2,06
065-SV-43	4	3	22,5	2,29
065-SV-44	4	4	23,8	2,29
065-SV-64	6	4	24,0	2,35
065-SV-66	6	6	25,1	2,38

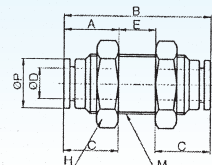

MINI Schott-Steckverbinder (Typ QSMS-B)

Schlauch						
Bestell-Nr.	Ø	B	E max.	H	T	Euro
065-S-3	3	20,0	7,5	10	M8x0,75	3,13
065-S-4	4	24,0	7,5	12	M10x1	3,22
065-S-6	6	25,9	6,0	14	M12x1	3,31

MINI Winkel-Schott-Steckverbinder (Typ QSMLS-B)

Bestell-Nr.	Schlauch						Euro
	Ø	B	Ø P1	E	Ø J	M	
065-WS-3	3	22,4	6,3	10,6	12,5	M8 x 0,75	4,47
065-WS-4	4	24,4	8,0	15,3	14,0	M10 x 0,75	4,47
065-WS-6	6	31,5	10,4	16,3	17,0	M12 x 0,75	4,83

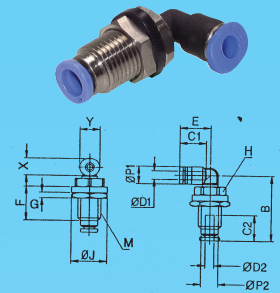

MINI L-Steckverbinder (Typ QSML-B)

Bestell-Nr.	Schlauch			Euro
	Ø	B	Ø P	
065-L-3	3	11,4	6,0	2,06
065-L-4	4	13,9	8,0	2,21
065-L-6	6	15,4	10,5	2,38

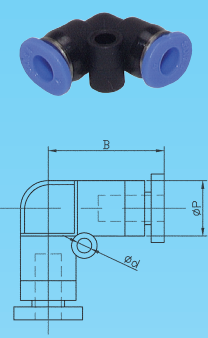

MINI T-Steckverbindungen (Typ QSMT-B) - auch reduzierend

Bestell-Nr.	Schlauch		B	Ø P	Euro
	2 x Ø D1	1 x Ø D2			
065-T-33	3	3	11,4	6,0	2,38
065-T-43	4	3	-	-	8,73
065-T-44	4	4	13,9	8,0	3,16
065-T-64	6	4	-	-	9,42
065-T-66	6	6	15,4	10,2	2,95

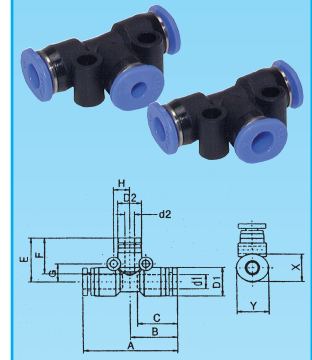

MINI Y-Steckverbindungen (Typ QSMY-B) - auch reduzierend

Bestell-Nr.	Schlauch		B	Euro
	1 x Ø D1	2 x Ø D2		
065-Y-33	3	3	29,9	2,41
065-Y-43	4	3	30,0	3,01
065-Y-44	4	4	30,1	2,86
065-Y-64	6	4	31,5	3,31
065-Y-66	6	6	32,1	3,07

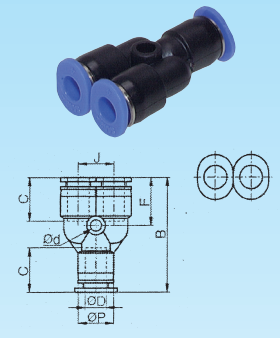

MINI X-Steckverbinder (Typ QSMX-B)

Bestell-Nr.	Schlauch				Euro
	Ø	E	Ø P	F	
065-X-3	3	11,5	6,0	4,5	4,44
065-X-4	4	13,6	8,0	5,5	4,59
065-X-6	6	15,9	10,4	6,5	4,89

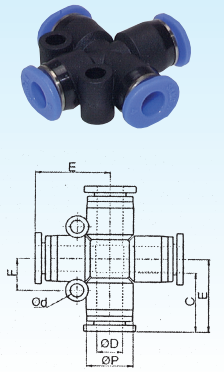

MINI Steckverbinder (Typ QSM-H-B) - mit Stecknippel - reduzierend

Bestell-Nr.	Schlauch		B	Ø P	Euro
	Ø D1	Ø D2			
065-SN-4-3	3	4	29,2	6,5	2,38
065-SN-6-4	4	6	33,2	9,0	2,53

MINI L-Steckverbindungen (Typ QSML-H-B) - mit Stecknippel

Bestell-Nr.	Schlauch				Euro
	Ø	B	Ø P	E	
066-L-3	3	21,6	6,0	11,2	1,94
066-L-4	4	27,6	8,0	15,6	2,06
066-L-6	6	29,6	10,5	16,9	2,38

MINI Y-Steckverbindungen / auch reduzierend (Typ QSMY-H-B)

Bestell-Nr.	Schlauch		B	Euro
	Ø D1	Ø D2		
066-Y-33	3	3	43,5	3,07
066-Y-43	4	3	33,0	3,22
066-Y-44	4	4	45,0	3,61
066-Y-64	6	4	38,5	3,70
066-Y-66	6	6	50,5	3,70

MINI Stopfen für Steckanschlüsse (Typ QSMC-B)

Bestell-Nr.	Schlauch				Euro
	Ø	B	Ø P	C	
060-3	3	22	4	9,5	0,63
060-4	4	28	4	15,0	0,66
060-6	6	32	6	17,0	0,66

MINI Steckkappen für Schläuche (Typ QSMC-B)

Bestell-Nr.	Schlauch				Euro
	Ø	B	Ø P	C	
061-3	3	10,7	6,0	9,5	0,80
061-4	4	12,0	8,0	11,5	0,89
061-6	6	12,5	10,5	12,5	0,95

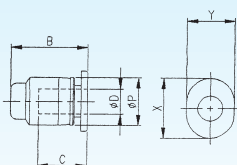
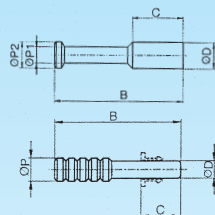
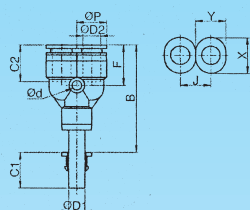
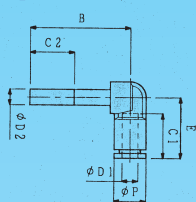
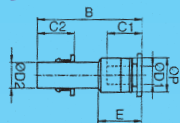

Funktionsverschraubungen und Ventile

Steckanschlüsse selbstabsperrend - Kupplungen

Anwendung: Die eingebaute Sperre (Ventilkörper) blockiert den Luftstrom sobald der Schlauch aus der Funktionsverschraubung gelöst wird. Nach der Schlauchmontage wird der Luftstrom wieder freigegeben.

Medium: Druckluft, nicht für Wasser oder andere Flüssigkeiten verwendbar

Temperatur: 0 °C bis max. +60 °C

Druck: bis 10 bar und Grobvakuum

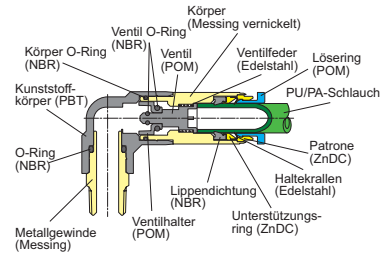

L-Steckverschraubungen selbstabsperrend (Typ QSKL-B) - drehbar

Bestell-Nr.	Schlauch							Euro
	Ø	Gewinde	B	Ø P	E	A	H	
070-18-4	4	R1/8	24,6	10,0	30,7	8	10	4,56
070-18-6	6	R1/8	24,0	12,8	31,9	8	12	4,86
070-18-8	8	R1/8	27,0	14,4	40,8	8	14	5,39
070-14-6	6	R1/4	28,0	12,8	31,9	11	14	5,01
070-14-8	8	R1/4	31,0	14,4	40,8	11	14	5,57
070-14-10	10	R1/4	35,0	17,6	47,6	11	17	7,15
070-38-8	8	R3/8	32,0	14,4	40,8	12	17	6,29
070-38-10	10	R3/8	36,0	17,6	47,6	12	17	7,24
070-38-12	12	R3/8	38,0	21,0	55,5	12	21	9,89
070-12-10	10	R1/2	39,0	17,6	47,6	15	21	8,20
070-12-12	12	R1/2	41,0	21,0	55,5	15	21	10,13

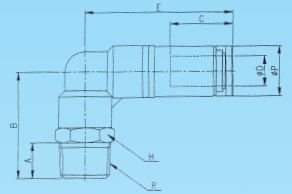

L-Steckverschraubungen selbstabsperrend (Typ QSKL-G-B) - drehbar

Bestell-Nr.	Schlauch		Euro
	Ø	Gewinde	
070-5-4	4	M5	5,36
070-5-6	6	M5	5,66
070G-18-4	4	G1/8	5,01
070G-18-6	6	G1/8	5,33
070G-18-8	8	G1/8	5,93
070G-14-6	6	G1/4	5,51
070G-14-8	8	G1/4	6,11
070G-14-10	10	G1/4	7,84
070G-38-8	8	G3/8	6,94
070G-38-10	10	G3/8	7,96
070G-38-12	12	G3/8	10,88
070G-12-10	10	G1/2	9,03
070G-12-12	12	G1/2	11,12

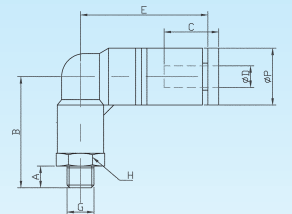

Steckverschraubungen selbstabsperrend (Typ QSK-B)

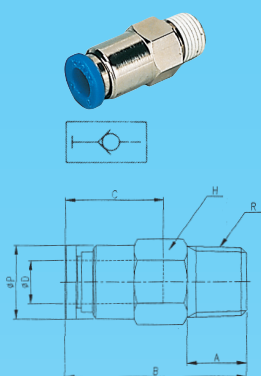

Schlauch							Euro
Bestell-Nr.	Ø	Gewinde	B	C	A	H	
071-18-4	4	R1/8	25,5	16,0	8	10	4,17
071-18-6	6	R1/8	27,8	17,0	8	12	4,23
071-14-6	6	R1/4	27,8	17,0	11	14	4,41
071-14-8	8	R1/4	31,8	18,5	11	14	4,95
071-14-10	10	R1/4	36,1	21,0	11	17	6,20
071-38-8	8	R3/8	31,8	18,5	12	17	6,02
071-38-10	10	R3/8	36,1	21,0	12	17	6,23
071-38-12	12	R3/8	44,4	22,0	12	21	7,24
071-12-10	10	R1/2	36,1	21,0	15	21	7,09
071-12-12	12	R1/2	44,2	22,0	15	21	7,45

Steckverschraubungen selbstabsperrend (Typ QSK-G-B)

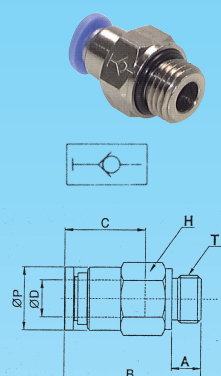

Schlauch			Euro
Bestell-Nr.	Ø	Gewinde	
071-5-4	4	M5	7,84
071G-18-4	4	G1/8	4,56
071G-18-6	6	G1/8	4,71
071G-14-6	6	G1/4	4,86
071G-14-8	8	G1/4	5,42
071G-14-10	10	G1/4	6,82
071G-38-8	8	G3/8	6,62
071G-38-10	10	G3/8	6,85
071G-38-12	12	G3/8	7,96
071G-12-10	10	G1/2	7,81
071G-12-12	12	G1/2	8,20

Steckverbindungen selbstabsperrend (Typ QSK-B)

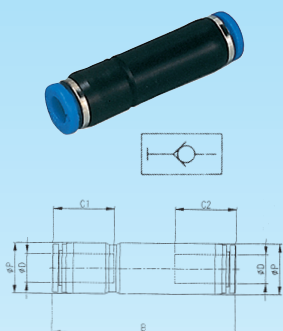

Schlauch				Euro
Bestell-Nr.	Ø	B	Ø P	
072-4	4	42,9	10,0	4,56
072-6	6	46,9	12,4	5,51
072-8	8	52,6	14,4	6,08
072-10	10	59,2	17,6	6,85
072-12	12	71,8	21,2	7,15

Steckverbindungen selbstabsperrend (Typ QSKS-B) - mit Schottgewinde

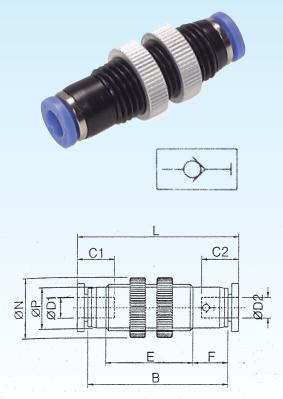

Schlauch			Euro
Bestell-Nr.	Ø		
073-4	4		7,03
073-6	6		7,99
073-8	8		9,18
073-10	10		11,06
073-12	12		15,29

Weitere Kupplungen und Zubehör finden Sie im Kapitel F.

Steckanschlüsse mit Rückschlagventil

Anwendung: Sperrung einer Durchflussrichtung.
Der Durchfluss ist nur in Pfeilrichtung geöffnet.

Temperatur: 0 °C bis max. +60 °C

Druck: bis 10 bar und Grobvakuum

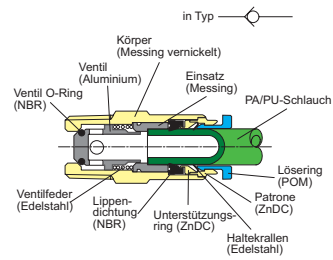

Rückschlagventile (Typ HQS-B) - Öffnungsdruck < 0,2 bar

Bestell-Nr.	Schlauch			Euro
	Ø	B	Ø P	
074-4	4	41,1	10,0	6,68
074-6	6	47,2	12,4	7,57
074-8	8	51,8	14,4	9,27
074-10*	10	-	-	20,80
074-12*	12	-	-	21,87

* Werkstoff Aluminium

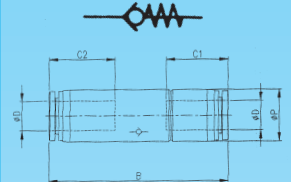

Rückschlagventile (Typ HAQS-B) - Öffnungsdruck < 0,2 bar

Bestell-Nr.	Schlauch						Euro
	Ø	Gewinde	B	Ø P	A	H	
075-18-4	4	R1/8	24,7	9,6	8	10	6,29
075-18-6	6	R1/8	28,6	11,6	8	12	7,18
075-18-8	8	R1/8	30,5	13,6	8	14	8,02
075-14-6	6	R1/4	28,6	11,6	11	14	7,57
075-14-8	8	R1/4	35,1	13,6	11	14	8,40
075-38-10	10	R3/8	-	-	-	-	18,39
075-38-12	12	R3/8	-	-	-	-	19,04
075-12-12	12	R1/2	-	-	-	-	19,91

← Durchfluss

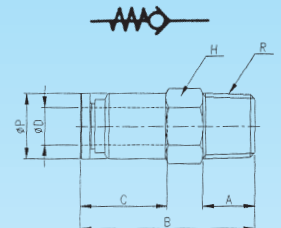

Rückschlagventile (Typ HAQS-G-B) - Öffnungsdruck < 0,2 bar

Bestell-Nr.	Schlauch		Euro
	Ø	Gewinde	
075-5-4	4	M5	6,29
075G-18-4	4	G1/8	7,36
075G-18-6	6	G1/8	7,87
075G-18-8	8	G1/8	8,82
075G-14-6	6	G1/4	8,28
075G-14-8	8	G1/4	9,27
075G-38-10	10	G3/8	20,23
075G-38-12	12	G3/8	20,92
075G-12-12	12	G1/2	21,90

← Durchfluss

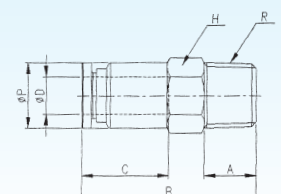

Rückschlagventile (Typ HBQS-B) - Öffnungsdruck < 0,2 bar

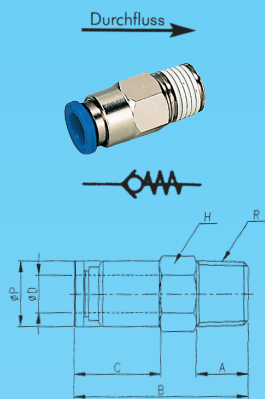

Schlauch						
Bestell-Nr.	Ø	Gewinde	B	A	H	Euro
076-18-4	4	R1/8	24,7	8	10	6,29
076-18-6	6	R1/8	28,6	8	12	7,18
076-18-8	8	R1/8	30,5	8	14	8,02
076-14-6	6	R1/4	28,6	11	14	7,57
076-14-8	8	R1/4	35,1	11	14	8,40
076-38-10	10	R3/8	-	-	-	18,39
076-38-12	12	R3/8	-	-	-	19,04
076-12-12	12	R1/2	-	-	-	19,91

Rückschlagventile (Typ HBQS-G-B) - Öffnungsdruck < 0,2 bar

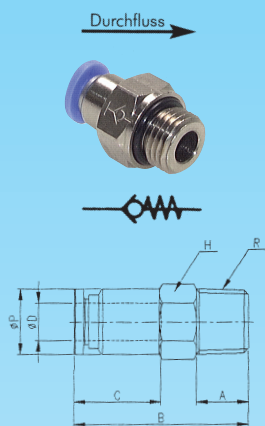

Schlauch				Euro
Bestell-Nr.	Ø	Gewinde		
076-5-4	4	M5		6,29
076G-18-4	4	G1/8		7,36
076G-18-6	6	G1/8		7,87
076G-18-8	8	G1/8		8,82
076G-14-6	6	G1/4		8,28
076G-14-8	8	G1/4		9,27
076G-38-10	10	G3/8		20,23
076G-38-12	12	G3/8		20,92
076G-12-12	12	G1/2		21,90

Weitere Rückschlagventile finden Sie im Kapitel H ab Seite H13.

Drosselrückschlagventile und Drosselventile

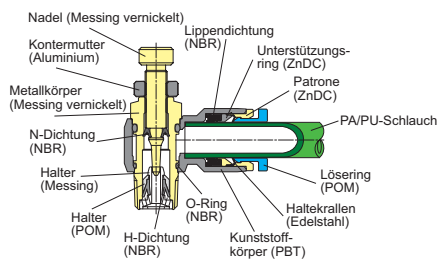

Drosselrückschlagventil (Typ GRLAQS-B) - drehbar - Abluft

Schlauch								Euro
Bestell-Nr.	Ø	Gewinde	L1	E	Ø K	A	H	
B086-18-4	4	R1/8	36,0	20,2	14,4	7,0	10	7,26
B086-18-6	6	R1/8	36,0	22,1	14,4	7,0	10	7,91
B086-18-8	8	R1/8	36,0	23,7	14,4	7,0	10	8,47
B086-14-4	4	R1/4	-	-	-	-	-	9,03
B086-14-6	6	R1/4	41,5	24,2	18,4	10,0	14	9,56
B086-14-8	8	R1/4	41,5	26,9	18,4	10,0	14	10,74
B086-14-10	10	R1/4	41,5	29,1	18,4	10,0	14	13,01
B086-14-12	12	R1/4	-	-	-	-	-	17,70
B086-38-6	6	R3/8	47,0	26,7	22,0	12,5	19	13,42
B086-38-8	8	R3/8	47,0	27,3	22,0	12,5	19	14,19
B086-38-10	10	R3/8	47,0	29,5	22,0	12,5	19	13,72
B086-38-12	12	R3/8	47,0	34,7	22,0	12,5	19	16,37
B086-12-8	8	R1/2	52,0	29,2	28,0	15,5	24	15,28
B086-12-10	10	R1/2	52,0	32,4	28,0	15,5	24	16,05
B086-12-12	12	R1/2	52,0	34,7	28,0	15,5	24	16,37

Drosselrückschlagventil (Typ GRLBQS-B) - drehbar - Zuluft

Schlauch								Euro
Bestell-Nr.	Ø	Gewinde	L1	E	Ø K	A	H	
A086-3-3	3	M3	-	-	-	-	-	7,64
A086-5-3	3	M5	26,5	14,7	10,0	3,5	8	5,55
A086-5-4	4	M5	26,5	18,5	10,0	3,5	8	5,55
A086-5-6	6	M5	26,5	21,7	10,0	3,5	8	6,76
A086-18-4	4	R1/8	36,0	20,2	14,4	7,0	10	7,26
A086-18-6	6	R1/8	36,0	22,1	14,4	7,0	10	7,91
A086-18-8	8	R1/8	36,0	23,7	14,4	7,0	10	8,47
A086-38-10	10	R3/8	47,0	29,5	22,0	12,5	19	14,51

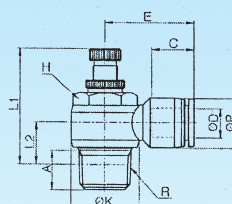
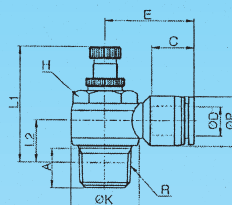

Drosselrückschlagventil (Typ GRLAQS-G-B) - drehbar - Abluft

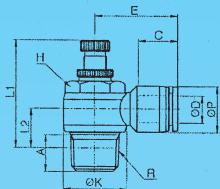

Schlauch								
Bestell-Nr.	Ø	Gewinde	L1	E	Ø K	A	H	Euro
B086-3-3	3	M3	-	-	-	-	-	7,64
B086-3-4	4	M3	-	-	-	-	-	7,64
B086-5-3	3	M5	26,5	14,7	10,0	3,5	8,0	5,55
B086-5-4	4	M5	26,5	18,5	10,0	3,5	8,0	5,55
B086-5-6	6	M5	26,5	21,7	10,0	3,5	8,0	6,76
B086G-18-4	4	G1/8	42,6	20,2	14,4	6,0	14,0	7,26
B086G-18-6	6	G1/8	42,6	22,1	14,4	6,0	14,0	7,91
B086G-18-8	8	G1/8	42,6	23,7	14,4	6,0	14,0	8,47
B086G-14-4	4	G1/4	-	-	-	-	-	9,03
B086G-14-6	6	G1/4	51,7	24,2	18,4	8,0	17,0	9,56
B086G-14-8	8	G1/4	51,7	26,9	18,4	8,0	17,0	10,74
B086G-14-10	10	G1/4	51,7	29,1	18,4	8,0	17,0	13,01
B086G-38-6	6	G3/8	58,3	26,7	22,0	10,0	20,0	13,42
B086G-38-8	8	G3/8	58,3	27,3	22,0	10,0	20,0	14,19
B086G-38-10	10	G3/8	58,3	29,5	22,0	10,0	20,0	13,72
B086G-38-12	12	G3/8	58,3	34,7	22,0	10,0	20,0	16,37
B086G-12-8	8	G1/2	59,8	29,2	28,0	12,0	24,0	15,28
B086G-12-10	10	G1/2	59,8	32,4	28,0	12,0	24,0	16,05
B086G-12-12	12	G1/2	59,8	34,7	28,0	12,0	24,0	16,37

360°
drehbar



Drosselrückschlagventil (Typ GRAQS-B) - drehbar - Abluft

Schlauch									
Bestell-Nr.	Ø	Gewinde	L1	Ø K	E	Ø P	A	H	Euro
B087-5-4	4	M5	26,5	10,4	15,9	10,4	3,5	8	7,40
B087-5-6	6	M5	26,5	10,4	15,9	12,4	3,5	10	8,91
B087-18-4	4	R1/8	36,0	14,4	18,1	10,4	8,0	10	8,91
B087-18-6	6	R1/8	36,0	14,4	18,1	12,4	8,0	14	10,56
B087-18-8	8	R1/8	36,0	14,4	18,1	14,4	8,0	14	11,30
B087-14-6	6	R1/4	41,5	18,4	20,1	12,4	11,2	19	11,30
B087-14-8	8	R1/4	41,5	18,4	20,1	14,4	11,2	19	11,30
B087-14-10	10	R1/4	41,5	18,4	20,1	17,6	11,2	19	11,30
B087-38-8	8	R3/8	47,0	22,0	22,5	14,4	13,3	24	15,19
B087-38-10	10	R3/8	47,0	22,0	22,5	17,6	13,3	24	15,19
B087-12-10	10	R1/2	52,0	28,0	24,9	17,6	16,5	19	17,17
B087-12-12	12	R1/2	52,0	28,0	24,9	21,2	16,5	14	17,49

Drosselrückschlagventil (Typ QSDRV-B)



Schlauch							
Bestell-Nr.	Ø	B	G	F	S	A	Euro
B088-3	3	36,2	13,5	4,3	6,5	10	7,26
B088-4	4	38,4	13,5	6,5	6,5	11	7,20
B088-6	6	47,2	18,5	8,5	11	15	9,85
B088-8	8	51,8	19	9,5	12	18	10,47
B088-10	10	59,6	23	11	12	21	14,01
B088-12	12	71,4	20,5	13	16	28	16,17

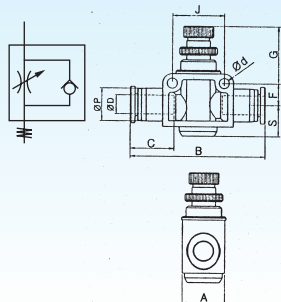

Drosselrückschlagventil TYP A = Zuluft

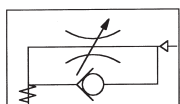

Drosselrückschlagventil TYP B = Abluft

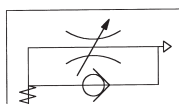

Drosselventil TYP C = beidseitig drosselbar

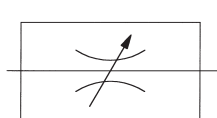

Drosselrückschlagventile und Drosselventile

Mit Ringstück Messing vernickelt komplett einbaufertig montiert

Bestell-Nr. Typ A Zuluft	Bestell-Nr. Typ B Abluft	Bestell-Nr. Typ C	Gewinde	Schlauch	Euro
A912-5-4L	B912-5-4L	C912-5-4L	M5	für AD 4 mm	12,47
A912-5-5L	B912-5-5L	C912-5-5L	M5	für AD 5 mm	12,47
A912-5-6L	B912-5-6L	C912-5-6L	M5	für AD 6 mm	12,47

Drosselrückschlagventile und Drosselventile

Mit Steck-Ringstück Messing vernickelt komplett einbaufertig montiert

Bestell-Nr. Typ A Zuluft	Bestell-Nr. Typ B Abluft	Bestell-Nr. Typ C	Schlauch		A	B	L	SW	Euro
			Ø aussen	Gewinde					
A912-18-4L	B912-18-4L	C912-18-4L	4	G1/8	14	27,5	37	14	7,30
A912-18-5L	B912-18-5L	C912-18-5L	5	G1/8	14	29,0	37	14	7,30
A912-18-6L	B912-18-6L	C912-18-6L	6	G1/8	14	30,0	37	14	7,30
A912-18-8L	B912-18-8L	C912-18-8L	8	G1/8	14	38,0	37	14	7,50
A912-14-6L	B912-14-6L	C912-14-6L	6	G1/4	18	33,0	38	17	8,20
A912-14-8L	B912-14-8L	C912-14-8L	8	G1/4	18	35,5	38	17	8,40
A912-14-10L	B912-14-10L	C912-14-10L	10	G1/4	18	35,5	38	17	8,60

Drosselrückschlagventile und Drosselventile

Mit Ringstück Messing vernickelt komplett einbaufertig montiert

Bestell-Nr. Typ A Zuluft	Bestell-Nr. Typ B Abluft	Bestell-Nr. Typ C	Gewinde	Schlauch	Euro
A913-5-4L	B913-5-4L	C913-5-4L	M5	für AD 4 mm	9,75
A913-5-5L	B913-5-5L	C913-5-5L	M5	für AD 5 mm	9,75
A913-5-6L	B913-5-6L	C913-5-6L	M5	für AD 6 mm	9,75

Drosselrückschlagventile und Drosselventile

Mit Steck-Ringstück Messing vernickelt komplett einbaufertig montiert

Bestell-Nr. Typ A Zuluft	Bestell-Nr. Typ B Abluft	Bestell-Nr. Typ C	Schlauch		A	B	L	SW	Euro
			Ø aussen	Gewinde					
A913-18-4L	B913-18-4L	C913-18-4L	4	G1/8	14	27,5	24	14	6,80
A913-18-5L	B913-18-5L	C913-18-5L	5	G1/8	14	29,0	24	14	6,80
A913-18-6L	B913-18-6L	C913-18-6L	6	G1/8	14	30,0	24	14	6,80
A913-18-8L	B913-18-8L	C913-18-8L	8	G1/8	14	38,0	24	14	7,00
A913-14-6L	B913-14-6L	C913-14-6L	6	G1/4	18	33,0	27	17	7,60
A913-14-8L	B913-14-8L	C913-14-8L	8	G1/4	18	35,5	27	17	7,80
A913-14-10L	B913-14-10L	C913-14-10L	10	G1/4	18	35,5	27	17	8,00

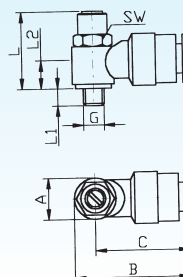
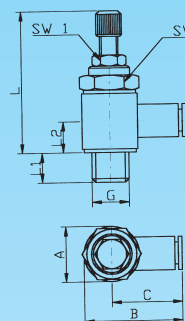



Drosselrückschlagventile und Drosselventile

Mit Ringstück Messing vernickelt komplett einbaufertig montiert

Bestell-Nr. Typ A Zuluft	Bestell-Nr. Typ B Abluft	Bestell-Nr. Typ C	Gewinde	Schlauch	Euro
A914-5-4L	B914-5-4L	C914-5-4L	M5	für AD 4 mm	12,47
A914-5-5L	B914-5-5L	C914-5-5L	M5	für AD 5 mm	12,47
A914-5-6L	B914-5-6L	C914-5-6L	M5	für AD 6 mm	12,47



Drosselrückschlagventile und Drosselventile

Mit Steck-Ringstück Messing vernickelt komplett einbaufertig montiert

Bestell-Nr. Typ A Zuluft	Bestell-Nr. Typ B Abluft	Bestell-Nr. Typ C	Schlauch			Euro
			Ø außen	Gewinde	SW	
A914-18-4L	B914-18-4L	C914-18-4L	4	G1/8	14	7,30
A914-18-5L	B914-18-5L	C914-18-5L	5	G1/8	14	7,30
A914-18-6L	B914-18-6L	C914-18-6L	6	G1/8	14	7,30
A914-18-8L	B914-18-8L	C914-18-8L	8	G1/8	14	7,50
A914-14-6L	B914-14-6L	C914-14-6L	6	G1/4	17	8,20
A914-14-8L	B914-14-8L	C914-14-8L	8	G1/4	17	8,40
A914-14-10L	B914-14-10L	C914-14-10L	10	G1/4	17	8,60

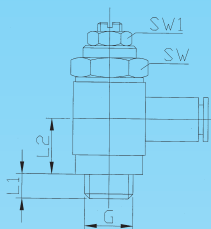

Drosselrückschlagventile und Drosselventile - Blockform mit Steck-Anschlüssen

Alu blau, Durchflussdiagramm finden Sie auf Seite H28

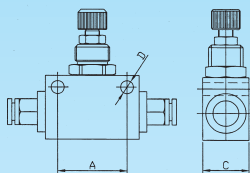

Bestell-Nr. Drosselrück- schlagventil	Bestell-Nr. Drossel- ventil	Schlauch Ø	Gewinde für Schalttafel- einbau	Euro			Drosselrück- schlagventil	Drossel- ventil
				A	C	D		
922-5-4ALB	923-5-4ALB	4	M10x1	18	14	4,5	11,08	11,08
922-5-6ALB	923-5-6ALB	6	M10x1	18	14	4,5	11,20	11,20
922-18-4ALB	923-18-4ALB	4	M12x1	24	16	4,5	10,74	10,74
922-18-6ALB	923-18-6ALB	6	M12x1	24	16	4,5	10,71	10,71
922-18-8ALB	923-18-8ALB	8	M12x1	24	16	4,5	10,80	10,80
922-18-10ALB	923-18-10ALB	10	M12x1	24	16	4,5	11,30	11,30
922-14-4ALB	923-14-4ALB	4	M20x1,5	35	25	6,5	14,49	14,49
922-14-6ALB	923-14-6ALB	6	M20x1,5	35	25	6,5	14,43	14,43
922-14-8ALB	923-14-8ALB	8	M20x1,5	35	25	6,5	14,46	14,46
922-14-10ALB	923-14-10ALB	10	M20x1,5	35	25	6,5	14,81	14,81
922-14-12ALB	923-14-12ALB	12	M20x1,5	35	25	6,5	15,37	15,37
922-38-6ALB	923-38-6ALB	6	M24x1,5	43	30	6,5	25,33	25,33
922-38-8ALB	923-38-8ALB	8	M24x1,5	43	30	6,5	25,30	25,30
922-38-10ALB	923-38-10ALB	10	M24x1,5	43	30	6,5	25,47	25,47
922-38-12ALB	923-38-12ALB	12	M24x1,5	43	30	6,5	25,94	25,94
922-38-14ALB	923-38-14ALB	14	M24x1,5	43	30	6,5	28,78	28,78
922-38-16ALB	923-38-16ALB	16	M24x1,5	43	30	6,5	28,81	28,81
922-12-8ALB	923-12-8ALB	8	M25x1,5	50	30	6,5	27,08	27,08
922-12-10ALB	923-12-10ALB	10	M25x1,5	50	30	6,5	27,02	27,02
922-12-12ALB	923-12-12ALB	12	M25x1,5	50	30	6,5	27,38	27,38
922-12-14ALB	923-12-14ALB	14	M25x1,5	50	30	6,5	29,95	29,95
922-12-16ALB	923-12-16ALB	16	M25x1,5	50	30	6,5	29,59	29,59

Das komplette Ventilprogramm finden Sie in Kapitel H.

Dreh-Steckverschraubungen

Steckverschraubungen 360° rotierend

Anwendung: für 360° rotierende Bewegungen
zwischen 250 U/Min und 1500 U/Min

Temperatur: 0 °C bis max. +60 °C

Betriebsdruck: bis 10 bar und Grobvakuum

Medium: **Bitte unbedingt beachten:**
Alle Drehverschraubungen
ausschließlich mit Luft verwenden!

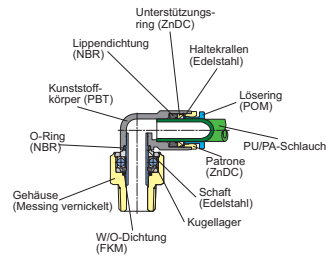

Steckverschraubungen (Typ QSR-B) - mit 1 Kugellager

Bestell-Nr.	Schlauch		U/min max.	B	A	H	Euro
	Ø	Gewinde					
077-18-4	4	R1/8	500	34,7	8	12*13	15,59
077-18-6	6	R1/8	500	36,5	8	14*15	16,57
077-18-8	8	R1/8	400	43,6	8	17*18	17,58
077-14-6	6	R1/4	500	36,5	11	14*15	16,57
077-14-8	8	R1/4	400	43,6	11	17*18	17,58
077-38-8	8	R3/8	400	43,6	12	17*18	17,58
077-38-10	10	R3/8	300	56,1	12	22*24	26,88
077-38-12	12	R3/8	250	61,5	12	24*26	36,53
077-12-10	10	R1/2	300	57,1	15	22*24	28,13
077-12-12	12	R1/2	250	61,5	15	24*26	34,96

Steckverschraubungen (Typ QSR-G-B) - mit 1 Kugellager

Bestell-Nr.	Schlauch		U/min max.	Euro
	Ø	Gewinde		
077-5-4	4	M5	500	15,75
077-5-6	6	M5	500	16,75
077G-18-4	4	G1/8	500	17,16
077G-18-6	6	G1/8	500	18,24
077G-18-8	8	G1/8	400	19,37
077G-14-6	6	G1/4	500	18,24
077G-14-8	8	G1/4	400	19,37
077G-38-8	8	G3/8	400	19,37
077G-38-10	10	G3/8	300	29,56
077G-38-12	12	G3/8	250	40,17
077G-12-10	10	G1/2	300	30,96
077G-12-12	12	G1/2	250	38,41

L-Steckverschraubungen (Typ QSRL-B) - mit 1 Kugellager

Bestell-Nr.	Schlauch		U/min max.	B	Ø P	F	H	Euro
	Ø	Gewinde						
078-18-4	4	R1/8	500	22,0	10,4	20,2	12*13	15,59
078-18-6	6	R1/8	500	24,2	12,4	22,9	14*15	16,57
078-18-8	8	R1/8	400	30,6	14,4	25,9	17*18	17,58
078-14-6	6	R1/4	500	26,2	12,4	22,9	14*15	16,57
078-14-8	8	R1/4	400	30,6	14,4	25,9	17*18	17,58
078-38-8	8	R3/8	400	30,6	14,4	25,9	17*18	17,58
078-38-10	10	R3/8	300	35,3	17,6	29,8	22*24	26,88
078-38-12	12	R3/8	250	40,5	21,0	32,7	24*26	36,53
078-12-10	10	R1/2	300	36,3	17,6	29,8	22*24	28,13
078-12-12	12	R1/2	250	40,5	21,0	32,7	24*26	34,96

360°
drehbar

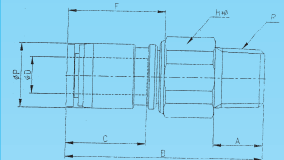

360°
drehbar

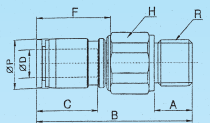

360°
drehbar

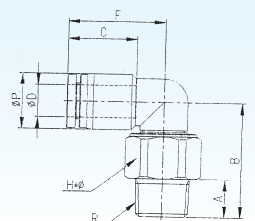

360°
drehbar

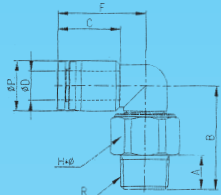

360°
drehbar

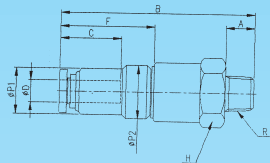

360°
drehbar

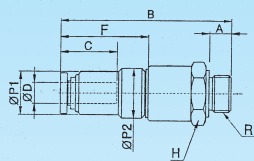

360°
drehbar

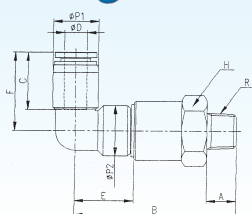

L-Steckverschraubungen (Typ QSRL-G-B) - mit 1 Kugellager

Bestell-Nr.	Schlauch		U/min	Euro
	Ø	Gewinde	max.	
078-5-4	4	M5	500	15,59
078-5-6	6	M5	500	16,57
078G-18-4	4	G1/8	500	17,16
078G-18-6	6	G1/8	500	18,24
078G-18-8	8	G1/8	400	19,37
078G-14-6	6	G1/4	500	18,24
078G-14-8	8	G1/4	400	19,37
078G-38-8	8	G3/8	400	19,37
078G-38-10	10	G3/8	300	29,56
078G-38-12	12	G3/8	250	40,17
078G-12-10	10	G1/2	300	30,96
078G-12-12	12	G1/2	250	38,41

Steckverschraubungen (Typ QSRH-B) - mit 2 Kugellager

Bestell-Nr.	Schlauch		U/min	B	A	H	Euro
	Ø	Gewinde	max.				
079-18-4	4	R1/8	1500	46,7	8	12	44,79
079-18-6	6	R1/8	1200	52,0	8	17	48,01
079-18-8	8	R1/8	1200	52,3	8	17	55,13
079-14-6	6	R1/4	1200	55,0	11	17	48,01
079-14-8	8	R1/4	1200	55,3	11	17	55,13
079-38-10	10	R3/8	900	64,8	12	24	78,73
079-38-12	12	R3/8	900	67,5	12	24	102,33
079-12-10	10	R1/2	900	67,8	15	24	78,73
079-12-12	12	R1/2	900	70,5	15	24	102,33

Steckverschraubungen (Typ QSRH-G-B) - mit 2 Kugellager

Bestell-Nr.	Schlauch		U/min	Euro
	Ø	Gewinde	max.	
079-5-4	4	M5	1500	44,79
079G-18-4	4	G1/8	1500	52,84
079G-18-6	6	G1/8	1200	56,65
079G-18-8	8	G1/8	1200	64,49
079G-14-6	6	G1/4	1200	56,65
079G-14-8	8	G1/4	1200	64,49
079G-38-10	10	G3/8	1000	92,11
079G-38-12	12	G3/8	1000	119,74
079G-12-10	10	G1/2	1000	92,11
079G-12-12	12	G1/2	1000	119,74

L-Steckverschraubungen (Typ QSRHL-B) - mit 2 Kugellager

Bestell-Nr.	Schlauch		U/min	B	Ø P	F	H	Euro
	Ø	Gewinde	max.					
080-18-4	4	R1/8	1500	37,5	10,0	20,2	12	37,04
080-18-6	6	R1/8	1200	43,2	12,4	22,9	17	39,72
080-18-8	8	R1/8	1200	44,2	14,4	25,9	17	46,37
080-14-6	6	R1/4	1200	46,2	12,4	22,9	17	39,72
080-14-8	8	R1/4	1200	47,2	14,4	25,9	17	46,37
080-38-10	10	R3/8	900	55,3	17,6	29,8	24	66,22
080-38-12	12	R3/8	900	57,0	21,0	33,7	24	86,06
080-12-10	10	R1/2	900	58,3	17,6	29,8	24	66,22
080-12-12	12	R1/2	900	60,0	21,0	33,7	24	86,06

L-Steckverschraubungen (Typ QSRHL-G-B) - mit 2 Kugellager

Bestell-Nr.	Schlauch		U/min max.	Euro
	Ø	Gewinde		
080-5-4	4	M5	1500	37,04
080G-18-4	4	G1/8	1500	52,84
080G-18-6	6	G1/8	1200	56,65
080G-18-8	8	G1/8	1200	64,49
080G-14-6	6	G1/4	1200	56,65
080G-14-8	8	G1/4	1200	64,49
080G-38-10	10	G3/8	1000	92,11
080G-38-12	12	G3/8	1000	119,74
080G-12-10	10	G1/2	1000	92,11
080G-12-12	12	G1/2	1000	119,74

Gerade Drehverschraubungen - drehbar - ohne Kugellager

Messing vernickelt, Dichtung: NBR

Bestell-Nr.	Außen-gewinde	Innen-gewinde	Euro
081DV-18	G1/8	G1/8	2,24
081DV-14	G1/4	G1/4	2,56
081DV-38	G3/8	G3/8	3,58

Drehverschraubungen (Typ GFS-B) - mit 2 Kugellager

Messing vernickelt, Dichtung: NBR

Bestell-Nr.	Gewinde	U/min max.	Euro
081-18	G1/8	1500	34,54
081-14	G1/4	1200	40,32
081-38	G3/8	1000	57,57
081-12	G1/2	1000	74,86

Drehverteiler 4-fach - 360° drehbar bis 300 U/min

Körper: Aluminium eloxiert, Drehzapfen: Edelstahl, Kugellager: Stahl, Dichtung: NBR

Bestell-Nr.	SW	Außen-gewinde	Innen-gewinde		Euro
081VT-14	17	G1/4"	4 x G1/4"	3x mit Stopfen verschlossen	167,00
081VT-38	19	G3/8"	4 x G3/8"	3x mit Stopfen verschlossen	167,00

360° drehbar

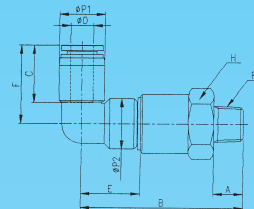

360° drehbar

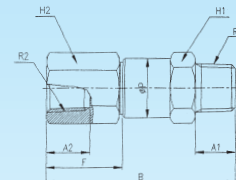

360° drehbar



Kugelhähne

Kugelhähne mit Steckanschlüssen 2/2 Wege

Anwendung: Absperrhähne ohne Entlüftung z.B. zum Trennen von 2 Systemen

Temperatur: 0 °C bis max. +60 °C

Betriebsdruck: bis 10 bar und Grobvakuum

Medium: **Bitte unbedingt beachten:**
Alle Kugelhähne Typ 082-.. bis 085-.. ausschließlich mit Luft verwenden!

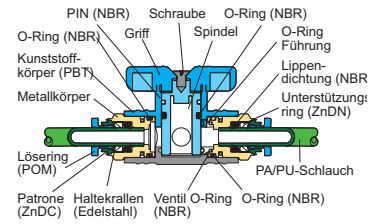

Kugelhähne (Typ QSKH-B) - drehbar - ohne Entlüftung

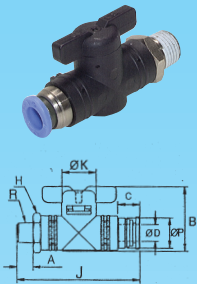

Schlauch						Euro
Bestell-Nr.	Ø	Gewinde	J	A	H	
082-18-6	6	R1/8	60,40	8	17	9,50
082-18-8	8	R1/8	60,30	8	17	9,50
082-14-6	6	R1/4	63,40	11	17	9,50
082-14-8	8	R1/4	63,30	11	17	9,50
082-14-10	10	R1/4	82,40	11	24	10,62
082-14-12	12	R1/4	82,85	11	24	10,62
082-38-6	6	R3/8	64,40	12	17	9,50
082-38-8	8	R3/8	64,30	12	17	9,50
082-38-10	10	R3/8	83,40	12	24	10,62
082-38-12	12	R3/8	83,85	12	24	10,62
082-12-10	10	R1/2	87,40	15	24	10,62
082-12-12	12	R1/2	87,85	15	24	10,62

Kugelhähne (Typ QSKH-G-B) - drehbar - ohne Entlüftung



Schlauch			Euro
Bestell-Nr.	Ø	Gewinde	
082G-18-6	6	G1/8	10,18
082G-18-8	8	G1/8	10,18
082G-14-6	6	G1/4	10,18
082G-14-8	8	G1/4	10,18
082G-14-10	10	G1/4	11,42
082G-14-12	12	G1/4	11,42
082G-38-6	6	G3/8	10,18
082G-38-8	8	G3/8	10,18
082G-38-10	10	G3/8	11,42
082G-38-12	12	G3/8	11,42
082G-12-10	10	G1/2	11,42
082G-12-12	12	G1/2	11,42

Kugelhähne (Typ QSKH-B) - drehbar - ohne Entlüftung

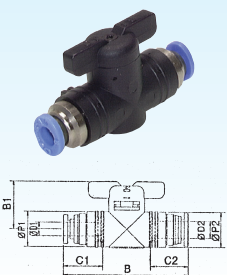

Schlauch				Euro
Bestell-Nr.	Ø	B	B1	
083-6	6	59,4	23	10,59
083-8	8	59,2	23	10,59
083-10	10	78,4	28	11,95
083-12	12	79,3	28	11,95

Schott-Kugelhähne (Typ QSKHS-B) - drehbar - ohne Entlüftung

Bestell-Nr.	Schlauch					Euro
	Ø	B	B1	H2	H1	
083SV-6	6	73,60	23	19	19	13,60
083SV-8	8	74,10	23	19	19	13,60
083SV-10	10	94,00	28	26	24	14,81
083SV-12	12	94,45	28	26	24	14,81

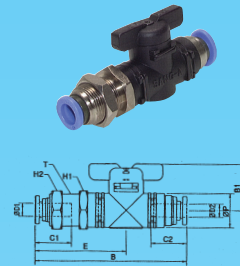

Winkel-Kugelhähne (Typ QSKHW-B) - drehbar - ohne Entlüftung

Bestell-Nr.	Schlauch						Euro
	Ø	Gewinde	B	B1	A	H	
084-18-6	6	R1/8	53,75	29,75	8	17	10,62
084-18-8	8	R1/8	53,75	30,25	8	17	10,62
084-14-6	6	R1/4	56,75	29,75	11	17	10,62
084-14-8	8	R1/4	56,75	30,25	11	17	10,62
084-14-10	10	R1/4	72,10	40,10	11	24	11,80
084-14-12	12	R1/4	72,10	40,00	11	24	11,80
084-38-6	6	R3/8	57,75	29,75	12	17	10,62
084-38-8	8	R3/8	57,75	30,25	12	17	10,62
084-38-10	10	R3/8	73,10	40,10	12	24	11,80
084-38-12	12	R3/8	73,10	40,00	12	24	11,80
084-12-10	10	R1/2	77,10	40,10	15	24	11,80
084-12-12	12	R1/2	77,10	40,00	15	24	11,80

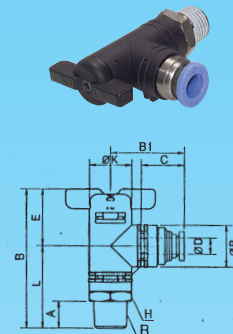

Winkel-Kugelhähne (Typ QSKHW-G-B) - drehbar - ohne Entlüftung

Bestell-Nr.	Schlauch		Euro
	Ø	Gewinde	
084G-18-6	6	G1/8	11,56
084G-18-8	8	G1/8	11,56
084G-14-6	6	G1/4	11,56
084G-14-8	8	G1/4	11,56
084G-14-10	10	G1/4	12,83
084G-14-12	12	G1/4	12,83
084G-38-6	6	G3/8	11,56
084G-38-8	8	G3/8	11,56
084G-38-10	10	G3/8	12,83
084G-38-12	12	G3/8	12,83
084G-12-10	10	G1/2	12,83
084G-12-12	12	G1/2	12,83

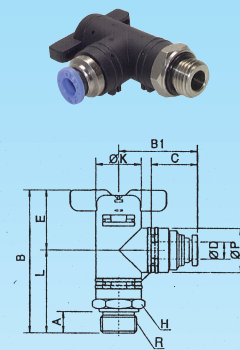

Winkel-Kugelhähne (Typ QSKHW-B) - ohne Entlüftung

Bestell-Nr.	Schlauch					Euro
	Ø	B	B1	Ø P1	Ø P2	
085-6	6	52,75	29,75	17	17	11,95
085-8	8	52,65	30,25	17	17	11,95
085-10	10	67,30	39,30	24	24	13,25
085-12	12	68,30	40,30	24	24	13,25

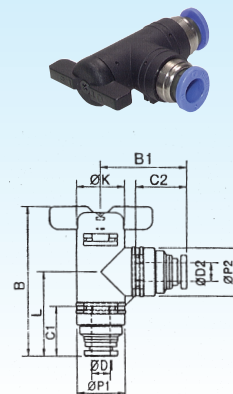

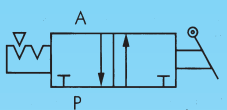
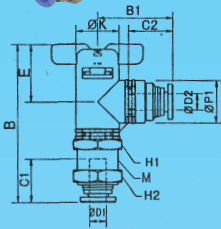

Winkel-Schott-Kugelhähne (Typ QSKHSW-B) - drehbar - ohne Entlüftung

Schlauch						
Bestell-Nr.	Ø	B	B1	H1	H2	Euro
085SV-6	6	63,15	23	19	19	14,81
085SV-8	8	67,20	23	19	19	14,81
085SV-10	10	84,50	28	24	26	15,93
085SV-12	12	84,00	28	24	26	15,93

Kugelhähne mit Steckanschlüssen 3/2 Wege

Anwendung: Absperrhähne mit Entlüftung z.B. zur Ansteuerung von einfachwirkenden Zylindern

Temperatur: 0 °C bis max. +60 °C

Betriebsdruck: bis 10 bar und Grobvakuum

Medium: **Bitte unbedingt beachten:**
Alle Kugelhähne Typ 090-.. bis 092-..
ausschließlich mit Luft verwenden!

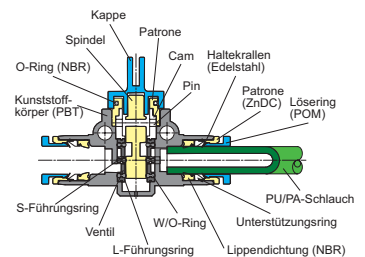

Kugelhähne (Typ QSHA-B) - drehbar - mit Entlüftung

Schlauch								
Bestell-Nr.	Ø	Gewinde	L	E	B1	J	H	Euro
090-18-6	6	R1/8	33,1	25,2	40,5	17,5	14	7,40
090-18-8	8	R1/8	33,1	27,7	40,5	17,5	14	7,97
090-14-6	6	R1/4	37,1	25,2	40,5	17,5	14	7,70
090-14-8	8	R1/4	37,1	27,7	40,5	17,5	14	8,29
090-14-10	10	R1/4	40,8	31,4	40,4	21,0	17	8,56
090-14-12	12	R1/4	40,8	34,3	40,4	21,0	17	9,15
090-38-6	6	R3/8	38,1	25,2	40,5	17,5	17	7,97
090-38-8	8	R3/8	38,1	27,7	40,5	17,5	17	8,56
090-38-10	10	R3/8	41,8	31,4	40,4	21,0	17	8,82
090-38-12	12	R3/8	41,8	34,3	40,4	21,0	17	9,38
090-12-10	10	R1/2	44,8	31,4	40,4	21,0	21	9,15
090-12-12	12	R1/2	44,8	34,3	40,4	21,0	21	9,68

Kugelhähne (Typ QSHA-G-B) - drehbar - mit Entlüftung

Schlauch			
Bestell-Nr.	Ø	Gewinde	Euro
090G-18-6	6	G1/8	7,99
090G-18-8	8	G1/8	8,56
090G-14-6	6	G1/4	8,29
090G-14-8	8	G1/4	8,91
090G-14-10	10	G1/4	9,20
090G-14-12	12	G1/4	9,82
090G-38-6	6	G3/8	8,56
090G-38-8	8	G3/8	9,20
090G-38-10	10	G3/8	9,50
090G-38-12	12	G3/8	10,12
090G-12-10	10	G1/2	9,82
090G-12-12	12	G1/2	10,38

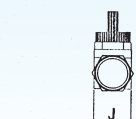
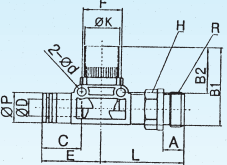
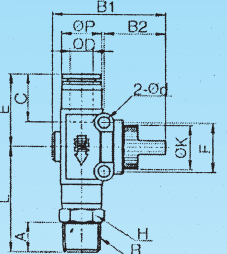

Kugelhähne (Typ QSHE-B) - drehbar - mit Entlüftung

Bestell-Nr.	Schlauch			L	E	B1	J	H	Euro
	Ø	Gewinde							
091-18-6	6	R1/8		33,1	25,2	40,5	17,5	14	7,40
091-18-8	8	R1/8		33,1	27,7	40,5	17,5	14	7,97
091-14-6	6	R1/4		37,1	25,2	40,5	17,5	14	7,70
091-14-8	8	R1/4		37,1	27,7	40,5	17,5	14	8,29
091-14-10	10	R1/4		40,8	31,4	40,4	21,0	17	8,56
091-14-12	12	R1/4		40,8	34,3	40,4	21,0	17	9,15
091-38-6	6	R3/8		38,1	25,2	40,5	17,5	17	7,97
091-38-8	8	R3/8		37,1	27,7	40,5	17,5	17	8,56
091-38-10	10	R3/8		41,8	31,4	40,4	21,0	17	8,82
091-38-12	12	R3/8		41,8	34,3	40,4	21,0	17	9,38
091-12-10	10	R1/2		44,8	31,4	40,4	21,0	21	9,15
091-12-12	12	R1/2		44,8	34,3	40,4	21,0	21	9,68

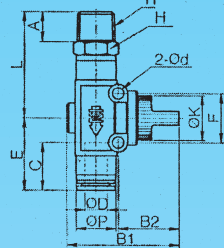

Kugelhähne (Typ QSHE-G-B) - drehbar - mit Entlüftung

Bestell-Nr.	Schlauch		Euro
	Ø	Gewinde	
091G-18-6	6	G1/8	7,99
091G-18-8	8	G1/8	8,56
091G-14-6	6	G1/4	8,29
091G-14-8	8	G1/4	8,91
091G-14-10	10	G1/4	9,20
091G-14-12	12	G1/4	9,82
091G-38-6	6	G3/8	8,56
091G-38-8	8	G3/8	9,20
091G-38-10	10	G3/8	9,50
091G-38-12	12	G3/8	10,12
091G-12-10	10	G1/2	9,82
091G-12-12	12	G1/2	10,38

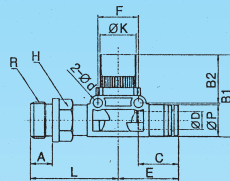

Kugelhähne (Typ QSH-B) - mit Entlüftung

Bestell-Nr.	Schlauch			Euro		
	Ø	E1	E2			
091-6	6	25,2	25,5	40,5	17,5	6,84
091-8	8	27,7	27,7	40,5	21,0	7,40
091-10	10	31,4	31,4	40,4	21,0	7,97
091-12	12	34,3	34,3	40,4	21,0	8,56

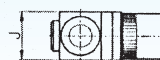
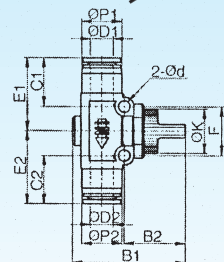

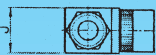
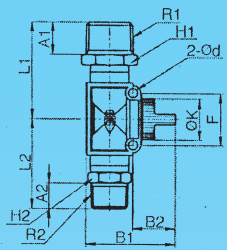

Kugelhähne (Typ QSH-B) - drehbar - mit Entlüftung

Bestell-Nr.	Gewinde	L1	L2	B1	J	H1	H2	Euro
092-18	R1/8	33,1	33,1	40,5	17,5	14	14	7,97
092-14	R1/4	37,1	37,1	40,5	17,5	14	14	9,15
092-38	R3/8	41,8	41,8	40,4	21,0	17	17	10,24
092-12	R1/2	44,9	44,9	40,4	21,0	21	21	11,36

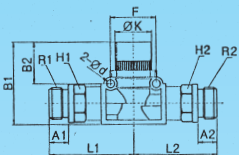

Kugelhähne (Typ QSH-G-B) - drehbar - mit Entlüftung

Bestell-Nr.	Gewinde	Euro
092G-18	G1/8	8,56
092G-14	G1/4	9,82
092G-38	G3/8	11,00
092G-12	G1/2	12,21

Weitere Kugelhähne finden Sie im Kapitel H ab Seite H22.